

## LM196/LM396 10 Amp Adjustable Voltage Regulator

### General Description

The LM196 is a 10 amp regulator, adjustable from 1.25V to 15V, which uses a revolutionary new IC fabrication structure to combine high power discrete transistor technology with modern monolithic linear IC processing. This combination yields a high-performance single-chip regulator capable of supplying in excess of 10 amps and operating at power levels up to 70 watts. The regulators feature on-chip trimming of reference voltage to  $\pm 0.8\%$  and simultaneous trimming of reference temperature drift to 30 ppm/ $^{\circ}\text{C}$  typical. Thermal interaction between control circuitry and the pass transistor which affects the output voltage has been reduced to extremely low levels by strict attention to isothermal layout. This interaction, called thermal regulation, is 100% tested.

These new regulators have all the protection features of popular lower power adjustable regulators such as LM117 and LM138, including current limiting and thermal limiting. The combination of these features makes the LM196 immune to blowout from output overloads or shorts, even if the adjustment pin is accidentally disconnected. All devices are "burned-in" in thermal shutdown to guarantee proper operation of these protective features under actual overload conditions.

Output voltage is continuously adjustable from 1.25V to 15V. Higher output voltages are possible if the maximum input-output voltage differential specification is not exceeded. Full load current of 10A is available at all output voltages, subject only to the maximum power limit of 70W and of course, maximum junction temperature.

The LM196 is exceptionally easy to use. Only two external resistors are used to set output voltage. On-chip adjustment of the reference voltage allows a much tighter specification of output voltage, eliminating any need for trimming in most cases. The regulator will tolerate an extremely wide range of reactive loads, and does not depend on external capacitors for frequency stabilization. Heat sink requirements are much less stringent, because overload situations do not have to be accounted for—only worst-case full load conditions.

The LM196 is in a TO-3 package with oversized (0.060") leads to provide best possible load regulation. Operating junction temperature range is  $-55^{\circ}\text{C}$  to  $+150^{\circ}\text{C}$ . The LM396 is specified for a  $0^{\circ}\text{C}$  to  $+125^{\circ}\text{C}$  junction temperature range.

### Features

- Output pre-trimmed to  $\pm 0.8\%$
- 10A guaranteed output current
- P<sup>+</sup> Product Enhancement tested
- 70W maximum power dissipation
- Adjustable output—1.25V to 15V
- Internal current and power limiting
- Guaranteed thermal resistance
- Output voltage guaranteed under worst-case conditions
- Output is short circuit protected

### Typical Applications

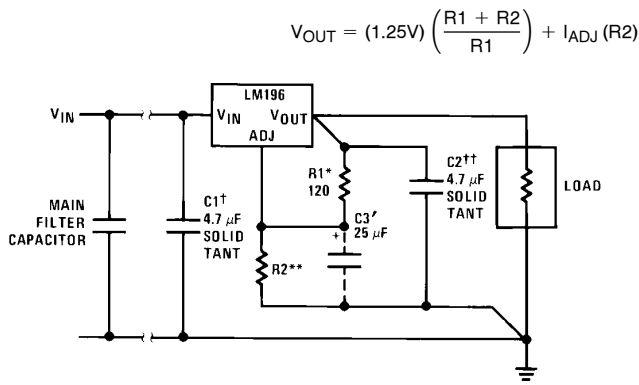

$$V_{OUT} = (1.25V) \left( \frac{R1 + R2}{R1} \right) + I_{ADJ}(R2)$$

\*For best TC of  $V_{OUT}$ , R1 should be wirewound or metal film, 1% or better.

\*\*R2 should be same type as R1, with TC tracking of 30 ppm/ $^{\circ}\text{C}$  or better.

†C1 is necessary only if main filter capacitor is more than 6" away, assuming #18 or larger leads.

††C2 is not absolutely necessary, but is suggested to lower high frequency output impedance. Output capacitors in the range of 1  $\mu\text{F}$  to 1000  $\mu\text{F}$  of aluminum or tantalum electrolytic are commonly used to provide improved output impedance and rejection of transients.

†C3 improves ripple rejection, output impedance, and noise. C2 should be 1  $\mu\text{F}$  or larger close to the regulator if C3 is used.

TL/H/9059-1

FIGURE 1. Basic 1.25V to 15V Regulator

## Absolute Maximum Ratings

If Military/Aerospace specified devices are required, please contact the National Semiconductor Sales Office/Distributors for availability and specifications.

Power Dissipation	Internally Limited
Input-Output Voltage Differential	20V
Operating Junction Temperature Range	
LM196 Control Section	–55°C to +150°C
Power Transistor	–55°C to +200°C
LM396 Control Section	0°C to +125°C
Power Transistor	0°C to +175°C

Storage Temperature	–65°C to +150°C
Lead Temperature (Soldering, 10 seconds)	300°C
ESD rating to be determined	

## Electrical Characteristics (Note 1)

Parameter	Conditions	LM196			LM396			Units
		Min	Typ	Max	Min	Typ	Max	
Reference Voltage	$I_{OUT} = 10\text{ mA}$	1.24	1.25	1.26	1.23	1.25	1.27	V
Reference Voltage (Note 2)	$V_{MIN} \leq (V_{IN} - V_{OUT}) \leq 20V$ $10\text{ mA} \leq I_{OUT} \leq 10A, P \leq P_{MAX}$ Full Temperature Range	1.22	1.25	1.28	1.21	1.25	1.29	V
Line Regulation (Note 3)	$V_{MIN} \leq (V_{IN} - V_{OUT}) \leq 20V$ Full Temperature Range		0.005	0.01 0.05		0.005	0.02 0.05	%/V %/V
Load Regulation LM196/LM396 (Note 4)	$10\text{ mA} \leq I_{OUT} \leq 10A$ $V_{MIN} \leq V_{IN} - V_{OUT} \leq 10V, P \leq P_{MAX}$ Full Temperature Range			0.1 0.15			0.1 0.15	%/A %/A
Ripple Rejection (Note 5)	$C_{ADJ} = 25\ \mu\text{F}, f = 120\text{ Hz}$ Full Temperature Range	60 54	74		66 54	74		dB dB
Thermal Regulation (Note 6)	$V_{IN} - V_{OUT} = 5V, I_{OUT} = 10A$		0.003	0.005		0.003	0.015	%/W
Average Output Voltage Temperature Coefficient	$T_{jMIN} \leq T_j \leq T_{jMAX}$ (See Curves for Limits)		0.003			0.003		%/°C
Adjustment Pin Current			50	100		50	100	$\mu\text{A}$
Adjustment Pin Current Change (Note 7)	$10\text{ mA} \leq I_{OUT} \leq 10A$ $3V \leq V_{IN} - V_{OUT} \leq 20V$ $P \leq P_{MAX}$ , Full Temperature Range			3			3	$\mu\text{A}$
Minimum Load Current (Note 9)	$2.5V \leq (V_{IN} - V_{OUT}) \leq 20V$ Full Temperature Range			10			10	mA
Current Limit (Note 8)	$2.5 \leq (V_{IN} - V_{OUT}) \leq 7V$ $V_{IN} - V_{OUT} = 20V$	10 1.5	14 3	20 8	10 1.5	14 3	20 8	A A
Rms Output Noise	$10\text{ Hz} \leq f \leq 10\text{ kHz}$		0.001			0.001		% $V_{OUT}$
Long Term Stability	$T_j = 125^\circ\text{C}, t = 1000\text{ Hours}$		0.3	1.0		0.3	1.0	%
Thermal Resistance Junction to Case (Note 10)	Control Circuitry Power Transistor		0.3 1.0	0.5 1.2		0.3 1.0	0.5 1.2	°C/W °C/W

## Electrical Characteristics (Note 1) (Continued)

Parameter	Conditions	LM196			LM396			Units
		Min	Typ	Max	Min	Typ	Max	
Power Dissipation ( $P_{MAX}$ ) (Note 11)	$7.0V \leq V_{IN} - V_{OUT} \leq 12V$	70	100		70	100		W
	$V_{IN} - V_{OUT} = 15V$	50			50			W
	$V_{IN} - V_{OUT} = 18V$	36			36			W
Drop-Out Voltage LM196/LM396	$I_{OUT} = 10A$ , Full Temperature Range		2.1	2.5 2.75		2.1	2.5 2.75	V

**Note 1:** Unless otherwise stated, these specifications apply for  $T_j = 25^\circ C$ ,  $V_{IN} - V_{OUT} = 5V$ ,  $I_{OUT} = 10\text{ mA}$  to  $10A$ .

**Note 2:** This is a worst-case specification which includes all effects due to input voltage, output current, temperature, and power dissipation. Maximum power ( $P_{MAX}$ ) is specified under Electrical Characteristics.

**Note 3:** Line regulation is measured on a short-pulse, low-duty-cycle basis to maintain constant junction temperature. Changes in output voltage due to thermal gradients or temperature changes must be taken into account separately. See discussion of Line Regulation under Application Hints.

**Note 4:** Load regulation on the 2-pin package is determined primarily by the voltage drop along the output pin. Specifications apply for an external Kelvin sense connection at a point on the output pin  $1/4$ " from the bottom of the package. Testing is done on a short-pulse-width, low-duty-cycle basis to maintain constant junction temperature. Changes in output voltage due to thermal gradients or temperature changes must be taken into account separately. See discussion of Load Regulation under Application Hints.

**Note 5:** Ripple rejection is measured with the adjustment pin bypassed with  $25\ \mu F$  capacitor, and is therefore independent of output voltage. With no load or bypass capacitor, ripple rejection is determined by line regulation and may be calculated from:  $RR = 20 \log_{10} [100/(K \times V_{OUT})]$  where K is line regulation expressed in %/V. At frequencies below 100 Hz, ripple rejection may be limited by thermal effects, if load current is above 1A.

**Note 6:** Thermal regulation is defined as the change in output voltage during the time period of 0.2 ms to 20 ms after a change in power dissipation in the regulator, due to either a change in input voltage or output current. See graphs and discussion of thermal effects under Application Hints.

**Note 7:** Adjustment pin current change is specified for the worst-case combination of input voltage, output current, and power dissipation. Changes due to temperature must be taken into account separately. See graph of adjustment pin current vs temperature.

**Note 8:** Current limit is measured 10 ms after a short is applied to the output. DC measurements may differ slightly due to the rapidly changing junction temperature, tending to drop slightly as temperature increases. A minimum available load current of 10A is guaranteed over the full temperature range as long as power dissipation does not exceed 70W, and  $V_{IN} - V_{OUT}$  is less than 7.0V.

**Note 9:** Minimum load current of 10 mA is normally satisfied by the resistor divider which sets up output voltage.

**Note 10:** Total thermal resistance, junction-to-ambient, will include junction-to-case thermal resistance plus interface resistance and heat sink resistance. See discussion of Heat Sinking under Application Hints.

**Note 11:** Although power dissipation is internally limited, electrical specifications apply only for power dissipation up to the limits shown. Derating with temperature is a function of both power transistor temperature and control area temperature, which are specified differently. See discussion of Heat Sinking under Application Hints. For  $V_{IN} - V_{OUT}$  less than 7V, power dissipation is limited by current limit of 10A.

**Note 12:** Dropout voltage is input-output voltage differential measured at a forced reference voltage of 1.15V, with a 10A load, and is a measurement of the minimum input/output differential at full load.

## Application Hints

Further improvements in efficiency can be obtained by using Schottky diodes or high efficiency diodes with lower forward voltage, combined with larger filter capacitors to reduce ripple. However, this reduces the voltage difference between input and drive pins and may not allow sufficient voltage to fully saturate the pass transistor. Special transformers are available from Signal Transformer that have a 1V tap on the output winding to provide the extra voltage for the drive pin. The transformers are available as standard items for 5V applications at 5A, 10A and 20A. Other voltages are available on special request.

### Heat Sinking

Because of its extremely high power dissipation capability, the *major limitation* in the load driving capability of the LM196 is *heat sinking*. Previous regulators such as LM109, LM340, LM117, etc., had internal power limiting circuitry which limited power dissipation to about 30W. The LM196

is guaranteed to dissipate up to 70W continuously, as long as the maximum junction temperature limit is not exceeded. This requires careful attention to all sources of thermal resistance from junction-to-ambient, including junction-to-case resistance, case-to-heat sink interface resistance ( $0.1-1.0^\circ C/W$ ), and heat sink resistance itself. A good thermal joint compound such as Wakefield type 120 or Thermalloy Thermocote must be used when mounting the LM196, especially if an electrical insulator is used to isolate the regulator from the heat sink. Interface resistance without this compound will be no better than  $0.5^\circ C/W$ , and probably much worse. With the compound, and no insulator, interface resistance will be  $0.2^\circ C/W$  or less, assuming  $0.005"$  or less combined flatness run-out of TO-3 and heat sink. Proper torquing of the mounting bolts is important to achieve minimum thermal resistance. Four to six inch pounds is recommended. Keep in mind that good electrical, as well as thermal, contact must be made to the case.

## Application Hints (Continued)

The actual heat sink chosen for the LM196 will be determined by the worst-case continuous full load current, input voltage and maximum ambient temperature. Overload or short circuit output conditions do not normally have to be considered when selecting a heat sink because the thermal shutdown built into the LM196 will protect it under these conditions. An exception to this is in situations where the regulator must recover very quickly from overload. The LM196 may take some time to recover to within specified output tolerance following an extended overload, if the regulator is cooling from thermal shutdown temperature (approximately 175°C) to specified operating temperature (125°C or 150°C). The procedure for heat sink selection is as follows:

Calculate worst-case *continuous* average power dissipation in the regulator from  $P = (V_{IN} - V_{OUT}) \times I_{OUT}$ . To do this, you must know the raw power supply voltage/current characteristics fairly accurately. For example, consider a 10V output with 15V nominal input voltage. At full load of 10A, the regulator will dissipate  $P = (15 - 10) \times (10) = 50W$ . If input voltage rises by 10%, power dissipation will increase to  $(16.5 - 10) \times (10) = 65W$ , a 30% increase. It is strongly suggested that a raw supply be assembled and tested to determine its average DC output voltage *under full load with maximum line voltage*. Do not over-design by using unloaded voltage as a worst-case, since the regulator will not be dissipating any power under no load conditions. Worst-case regulator dissipation normally occurs under full load conditions except when the effective DC resistance of the raw supply ( $\Delta V/\Delta I$ ) is larger than  $(V_{IN}^* - V_{OUT})/2I_{FL}$ , where  $V_{IN}^*$  is the lightly-loaded raw supply voltage and  $I_{FL}$  is full load current. For  $(V_{IN}^* - V_{OUT}) = 5V - 8V$ , and  $I_{FL} = 5A-10A$ , this gives a resistance of 0.25Ω to 0.8Ω. If raw supply resistance is higher than this, the regulator power dissipation may be less at full load current, then at some intermediate current, due to the large drop in input voltage. Fortunately, most well designed raw supplies have low enough output resistance that regulator dissipation does maximize at full load current, or very close to it, so tedious testing is not usually required to find worst-case power dissipation.

A very important consideration is the size of the filter capacitor in the raw supply. At these high current levels, capacitor size is usually dictated by ripple current ratings rather than just obtaining a certain ripple voltage. Capacitor ripple current (rms) is 2–3 times the DC output current of the filter. If the capacitor has just 0.05Ω DC resistance, this can cause 30W internal power dissipation at 10A output current. Capacitor life is very sensitive to operating temperature, decreasing by a factor of two for each 15°C rise in internal temperature. Since capacitor life is not all that great to start with, it is obvious that a small capacitor with a large internal temperature rise is inviting very short mean-time-to-failure. A second consideration is the loss of usable input voltage to the regulator. If the capacitor is small, the large dips in the input voltage may cause the LM196 to drop out of regulation. 2000 μF per ampere of load current is the *minimum* recommended value, yielding about 2 Vp-p ripple of 120 Hz. Larger values will have longer life and the reduced ripple will allow lower DC input voltage to the regulator, with subse-

quent cost savings in the transformer and heat sink. Sometimes several capacitors in parallel are better to decrease series resistance and increase heat dissipating area.

After the raw supply characteristics have been determined, and worst-case power dissipation in the LM196 is known, the heat sink thermal resistance can be found from the graphs titled Maximum Heat Sink Thermal Resistance. These curves indicate the minimum size heat sink required as a function of ambient temperature. They are derived from a case-to-control area thermal resistance of 0.5°C/W and a case-to-power transistor thermal resistance of 1.2°C/W. 0.2°C/W is assumed for interface resistance. A maximum control area temperature of 150°C is used for the LM196 and 125°C for the LM396. Maximum power transistor temperature is 200°C for the LM196 and 175°C for the LM396. For conservative designs, it is suggested that when using these curves, you assume an ambient temperature 25°C–50°C higher than is actually anticipated, to avoid running the regulator right at its design limits of operating temperature.

A quick look at the curves show that heat sink resistance ( $\theta_{SA}$ ) will normally fall into the range of 0.2°C/W–1.5°C/W. These are *not* small heat sinks. A model 441, for instance, which is sold by several manufacturers, has a  $\theta_{SA}$  of 0.6°C/W with natural convection and is about five inches on a side. Smaller sinks are more volumetrically efficient, and larger sinks, less so. A rough formula for estimating the volume of heat sink required is:  $V = 50/\theta_{SA}^{1.5}$  CU. IN. This holds for natural convection only. If the heat sink is inside a small sealed enclosure,  $\theta_{SA}$  will increase substantially because the air is not free to form natural convection currents. Fan-forced convection can reduce  $\theta_{SA}$  by a factor of two at 200 FPM air velocity, and by four at 1000 FPM.

### Ripple Rejection

Ripple rejection at the normal ripple frequency of 120 Hz is a function of both electrical and thermal effects in the LM196. If the adjustment pin is not bypassed with a capacitor, it is also dependent on output voltage. A 25 μF capacitor from the adjustment pin to ground will make ripple rejection independent of output voltage for frequencies above 100 Hz. If lower ripple frequencies are encountered, the capacitor should be increased proportionally.

To keep in mind that the bypass capacitor on the adjustment pin will limit the turn-on time of the regulator. A 25 μF capacitor, combined with the output divider resistance, will give an extended output voltage settling time following the application of input power.

### Load Regulation (LM196/LM396)

Because the LM196 is a three-terminal device, it is not possible to provide true remote load sensing. Load regulation will be limited by the resistance of the output pin and the wire connecting the regulator to the load. For the data sheet specification, regulation is measured 1/4" from the bottom of the package on the output pin. Negative side sensing is a true Kelvin connection, with the bottom of the output divider returned to the negative side of the load.

## Application Hints (Continued)

Although it may not be immediately obvious, best load regulation is obtained when the top of the divider is connected *directly* to the output pin, *not to the load*. This is illustrated in *Figure 2*. If R1 were connected to the load, the effective resistance between the regulator and the load would be

$$(R_w) \times \left( \frac{R_2 + R_1}{R_1} \right)$$

$R_w$  = Line Resistance

Connected as shown,  $R_w$  is not multiplied by the divider ratio.  $R_w$  is about 0.004 $\Omega$  per foot using 16 gauge wire. This translates to 40 mV/ft at 10A load current, so it is important to keep the positive lead between regulator and load as short as possible.

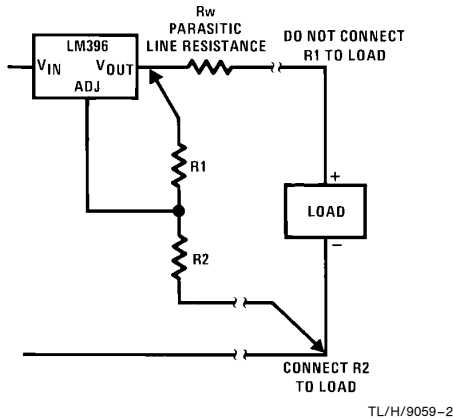

**FIGURE 2. Proper Divider Connection**

The input resistance of the sense pin is typically 6 k $\Omega$ , modeled as a resistor between the sense pin and the output pin. Load regulation will start to degrade if a resistance higher than 10 $\Omega$  is inserted in series with the sense. This assumes a worst-case condition of 0.5V between output and sense pins. Lower differential voltage will allow higher sense series resistance.

### Thermal Load Regulation

Thermal, as well as electrical, load regulation must be considered with IC regulators. Electrical load regulation occurs in microseconds, thermal regulation due to die thermal gradients occurs in the 0.2 ms-20 ms time frame, and regulation due to overall temperature changes in the die occurs over a 20 ms to 20 minute period, depending on the time constant of the heat sink used. Gradient induced load regulation is calculated from

$$\Delta V_{OUT} = (V_{IN} - V_{OUT}) \times (\Delta I_{OUT}) \times (\beta)$$

$\beta$  = Thermal regulation specified on data sheet.

For  $V_{IN} = 9V$ ,  $V_{OUT} = 5V$ ,  $\Delta I_{OUT} = 10A$ , and  $\beta = 0.005\%/W$ , this yields a 0.2% change in output voltage. Changes in output voltage due to overall temperature rise are calculated from

$$V_{OUT} = (V_{IN} - V_{OUT}) \times (\Delta I_{OUT}) \times (TC) \times (\theta_{JA})$$

$TC$  = Temperature coefficient of output voltage.

$\theta_{JA}$  = Thermal resistance from junction to ambient.  $\theta_{JA}$  is approximately 0.5°C/W +  $\theta$  of heat sink.

For the same conditions as before, with  $TC = 0.003\%/^{\circ}C$ , and  $\theta_{JA} = 1.5^{\circ}C/W$ , the change in output voltage will be 0.18%. Because these two thermal terms can have either polarity, they may subtract from, or add to, electrical load regulation. For worst-case analysis, they must be assumed to add. If the output of the regulator is trimmed under load, only that portion of the load that changes need be used in the previous calculations, significantly improving output accuracy.

### Line Regulation

Electrical line regulation is very good on the LM196—typically less than 0.005% change in output voltage for a 1V change in input. This level of regulation is achieved only for very low load currents, however, because of thermal effects. Even with a thermal regulation of 0.002%/W, and a temperature coefficient of 0.003%/°C, DC line regulation will be dominated by thermal effects as shown by the following example:

$$\text{Assume } V_{OUT} = 5V, V_{IN} = 9V, I_{OUT} = 8A$$

Following a 10% change in input voltage (0.9), the output will change quickly ( $\leq 100 \mu s$ ), due to electrical effects, by  $(0.005\%V) \times (0.9V) = 0.0045\%$ . In the next 20 ms, the output will change an additional  $(0.002\%/W) \times (8A) \times (0.9V) = 0.0144\%$  due to thermal gradients across the die. After a much longer time, determined by the time constant of the heat sink, the output will change an additional  $(0.003\%/^{\circ}C) \times (8A) \times (0.9V) \times (2^{\circ}C/W) = 0.043\%$  due to the temperature coefficient of output voltage and the thermal resistance from die to ambient. ( $2^{\circ}C/W$  was chosen for this calculation). The sign of these last two terms varies from part to part, so no assumptions can be made about any cancelling effects. All three terms must be added for a proper analysis. This yields  $0.0045 + 0.0144 + 0.043 = 0.062\%$  using *typical* values for thermal regulation and temperature coefficient. For worst-case analysis, the maximum data sheet specifications for thermal regulation and temperature coefficient should be used, along with the *actual* thermal resistance of the heat sink being used.

### Paralleling Regulators

Direct paralleling of regulators is not normally recommended because they do not share currents equally. The regulator with the highest reference voltage will supply all the current to the load until it current limits. With an 18A load, for instance, one regulator might be operating in current limit at 16A while the second device is only carrying 2A. Power dissipation in the high current regulator is extremely high with attendant high junction temperatures. Long term reliability cannot be guaranteed under these conditions.

Quasi-paralleling may be accomplished if load regulation is not critical. The connection shown in *Figure 5a* will typically share to within 1A, with a worst-case of about 3A. Load regulation is degraded by 150 mV at 20A loads. An external op amp may be used as in *Figure 5b* to improve load regulation and provide remote sensing.

## Application Hints (Continued)

### Input and Output Capacitors

The LM196 will tolerate a wide range of input and output capacitance, but long wire runs or small values of output capacitance can sometimes cause problems. If an output capacitor is used, it should be 1  $\mu\text{F}$  or larger. We suggest 10  $\mu\text{F}$  solid tantalum if significant improvements in high frequency output impedance are needed (see output impedance graph). This capacitor should be as close to the regulator as possible, with short leads, to reduce the effects of lead inductance. No input capacitor is needed if the regulator is within 6 inches of the power supply filter capacitor, using 18 gauge stranded wire. For longer wire runs, the LM196 input should be bypassed locally with a 4.7  $\mu\text{F}$  (or larger) solid tantalum capacitor, or a 100  $\mu\text{F}$  (or larger) aluminum electrolytic capacitor.

### Correcting for Output Wire Losses (LM196/LM396)

Three-terminal regulators can only provide partial Kelvin load sensing (see Load Regulation). Full remote sensing can be added by using an external op amp to cancel the effect of voltage drops in the unsensed positive output lead. In *Figure 7*, the LM301A op amp forces the voltage loss across the unsensed output lead to appear across R3. The current through R3 then flows out the  $V^-$  pin of the op amp through R4. The voltage drop across R4 will raise the output voltage by an amount equal to the line loss, just cancelling the line loss itself. A small ( $\approx 40$  mV) initial output voltage error is created by the quiescent current of the op amp. Cancellation range is limited by the maximum output current of the op amp, about 300 mV as shown. This can be raised by increasing R3 or R4 at the expense of more initial output error.

### Transformers and Diodes

Proper transformer ratings are very important in a high current supply because of the conflicting requirements of efficiency and tolerance to low-line conditions. A transformer with a high secondary voltage will waste power and cause unnecessary heating in the regulator. Too low a secondary voltage will cause loss of regulation under low-line conditions. The following formulas may be used to calculate the required secondary voltage and current ratings using a full-wave center tap:

$$V_{\text{rms}} = \left( \frac{V_{\text{OUT}} + V_{\text{REG}} + V_{\text{RECT}} + V_{\text{RIPPLE}}}{\sqrt{2}} \right) \left( \frac{V_{\text{NOM}}}{V_{\text{LOW}}} \right) (1.1)^*$$

$$I_{\text{rms}} = (I_{\text{OUT}}) (1.2) \quad (\text{Full-wave center tap})$$

where:

$V_{\text{OUT}}$  = DC regulated output voltage

$V_{\text{REG}}$  = Minimum input-output voltage of regulator

$V_{\text{RECT}}$  = Rectifier forward voltage drop at three times DC output current

$$V_{\text{RIPPLE}} = 1/2 \text{ peak-to-peak capacitor ripple voltage} \\ = \frac{(5.3 \times 10^{-3})(I_{\text{OUT}})}{2C}$$

\*The factor of 1.1 is only an approximate factor accounting for load regulation of the transformer.

$V_{\text{NOM}}$  = Nominal line voltage AC rms

$V_{\text{LOW}}$  = Low line voltage AC rms

$I_{\text{OUT}}$  = DC output current

Example:  $I_{\text{OUT}} = 10\text{A}$ ,  $V_{\text{OUT}} = 5\text{V}$

Assume:  $V_{\text{REG}} = 2.2\text{V}$ ,  $V_{\text{RECT}} = 1.2\text{V}$

$V_{\text{RIPPLE}} = 2 \text{ Vp-p}$ ,  $V_{\text{NOM}} = 115\text{V}$ ,

$V_{\text{LOW}} = 105\text{V}$

$$V_{\text{rms}} = \left( \frac{5 + 2.2 + 1.2 + 1}{\sqrt{2}} \right) \left( \frac{115}{105} \right) 1.1 \\ = 8.01 V_{\text{rms}}$$

$$\text{Capacitor } C = \frac{(5.3 \times 10^{-3})(I_{\text{OUT}})}{2 \times V_{\text{RIPPLE}}} \\ = \frac{(5.3 \times 10^{-3})(10)}{2} = 26,500 \mu\text{F}$$

The diodes used in a full-wave rectified capacitor input supply must have a DC current rating considerably higher than the average current flowing through them. In a 10A supply, for instance, the average current through each diode is only 5A, but the diodes should have a rating of 10A–15A. There are many reasons for this, both thermal and electrical. The diodes conduct current in pulses about 3.5 ms wide with a peak value of 5–8 times the average value, and an rms value 1.5–2.0 times the average value. This results in long term diode heating roughly equivalent to 10A DC current. The most demanding condition however, may be the one cycle surge through the diode during power turn on. The peak value of the surge is about 10–20 times the DC output current of the supply, or 100A–200A for a 10A supply. The diodes must have a one cycle non-repetitive surge rating of 200A or more, and this is usually not found in a diode with less than 10A average current rating. Keep in mind that even though the LM196 may be used at current levels below 10A, the diodes may still have to survive shorted output conditions where average current could rise to 12A–15A. Smaller transformers and filter capacitors used in lower current supplies will reduce surge currents, but unless specific information is available on worst-case surges, it is best not to economize on diodes. Stud-mounted devices in a DO-4 package are recommended. Cathode-to-case types may be bolted directly to the same heat sink as the LM196 because the case of the regulator is its power input. Part numbers to consider are the 1N1200 series rated at 12A average current in a DO-4 stud package. Additional types include common cathode duals in a TO-3 package, both standard and Schottky, and various duals in plastic filled assemblies. Schottky diodes will improve efficiency, especially in low voltage applications. In a 5V supply for instance, Schottky diodes will decrease wasted power by up to 6W, or alternatively provide an additional 5% “drop out” margin for low-line conditions. Several manufacturers are producing “high efficiency” diodes with a forward voltage drop nearly as good as Schottkys at high current levels. These devices do not have the low breakdown voltages of Schottkys, so are much less prone to reverse breakdown induced failures.

# Typical Performance Characteristics

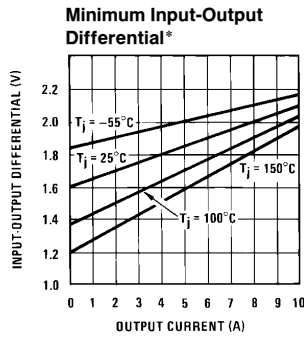
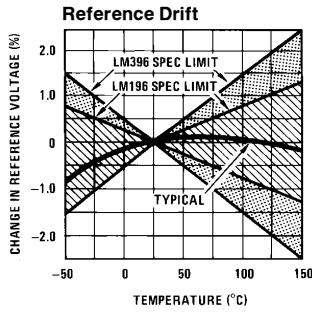

\* $V_{IN}$  is reduced until output drops 2%

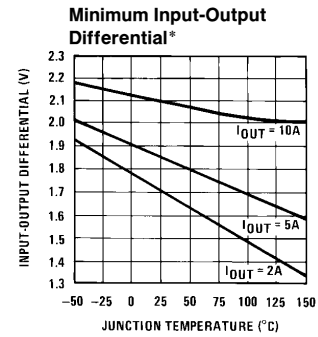

TL/H/9059-3

\* $V_{IN}$  is reduced until output drops 2%

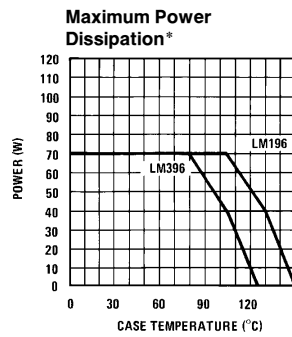
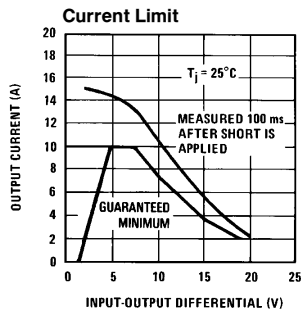

\*As limited by maximum junction temperature.

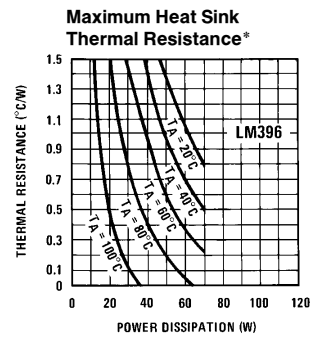

TL/H/9059-4

\*See "Heat Sinking" under Applications Hints.

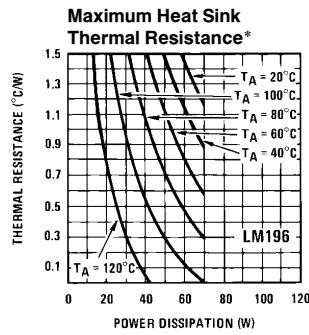

\*See "Heat Sinking" under Application Hints.

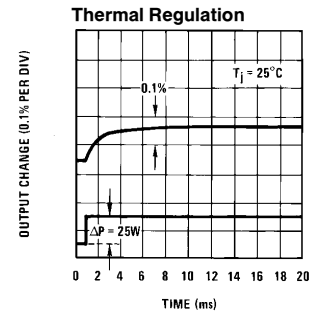
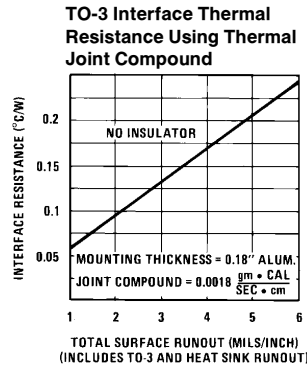

TL/H/9059-5

# Typical Performance Characteristics (Continued)

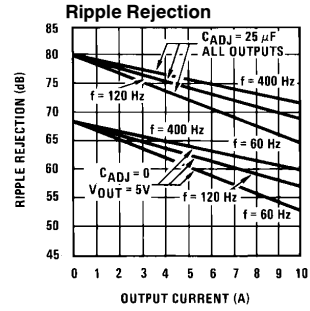
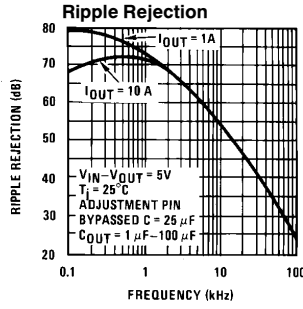
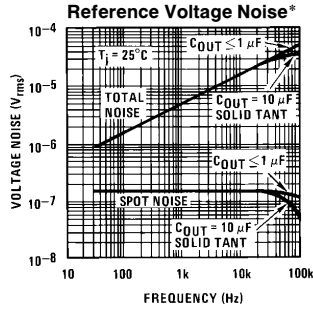

TL/H/9059-6

\*To obtain output noise, multiply by  $V_{OUT}/1.25$  if adjustment pins not bypassed.

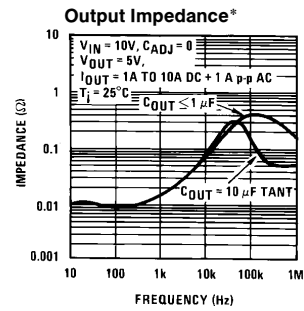
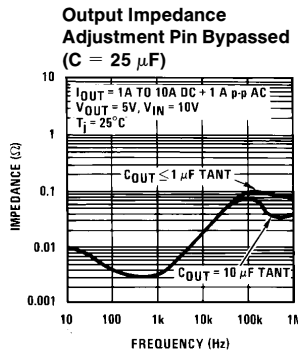
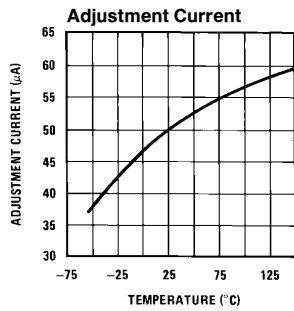

TL/H/9059-7

\*For output voltages other than 5V, multiply vertical scale readings by  $V_{OUT}/5$ .

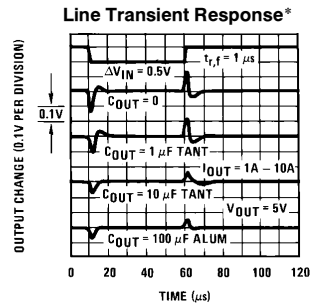
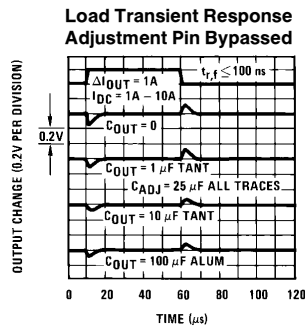
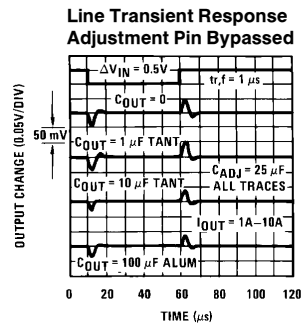

TL/H/9059-8

\*With no adjustment pin bypass. For output voltages other than 5V, multiply vertical scale by  $V_{OUT}/5$ .



## Typical Performance Characteristics (Continued)

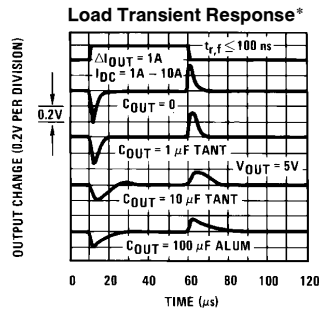

TL/H/9059-9

\*With no adjustment pin bypass. For output voltages other than 5V, multiply vertical scale by  $V_{OUT}/5$ .

## Typical Applications (Continued)

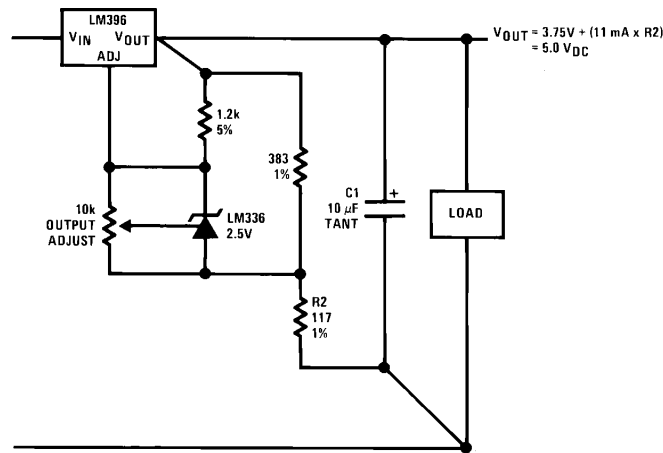

TL/H/9059-10

\*Regulation can be improved by adding an LM336 reference diode to increase the effective reference voltage to 3.75V. Load and line regulation are improved by 3:1, including thermal effects.

**FIGURE 3. Improving Regulation\***

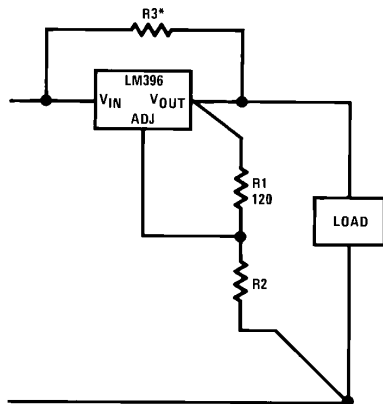

TL/H/9059-11

**FIGURE 4. Reducing Regulator Power Dissipation**

\*R3 is selected to supply partial load current. Therefore, a minimum load must always be maintained to prevent the regulated output from rising uncontrolled. R3 must be greater than  $(V_{MAX} - V_{OUT})/I_{MIN}$ , where  $V_{MAX}$  is worst-case high input voltage, and  $I_{MIN}$  is the minimum load current. R3 must be rated for at least  $(V_{IN} - V_{OUT})^2/R3$  watts. Regulator power dissipation will be reduced by a factor of 2-3 in a typical situation where minimum load current is 1/2 full load current. Regulator dissipation will peak at:

$$V_{IN} = \frac{(R3)(I_{OUT})}{2} + V_{OUT}$$

and will be equal to:

$$P_{MAX} = \frac{(R3)(I_{OUT})^2}{4} \text{ Assuming: } (R3)(I_{OUT}) \leq V_{MAX} - V_{OUT}$$

A few words of caution; (1) R3 power rating must be increased to  $(V_{MAX})^2/R3$  if continuous output shorts are possible. (2) Under normal load conditions, system power dissipation is not changed, but under short circuit conditions system power dissipation increases by  $(V_{IN})^2/R3$  watts over the already high power of a shorted regulator. The LM196 will not be harmed and neither will R3 if it is rated properly, but the raw supply components must be able to withstand the overload also. Thermal shutdown of the LM196 will probably occur for sustained shorts, somewhat alleviating the problem.

## Typical Applications (Continued)

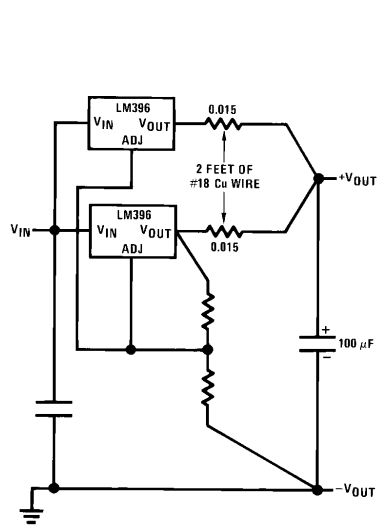

TL/H/9059-12

FIGURE 5a. Paralleling Regulators

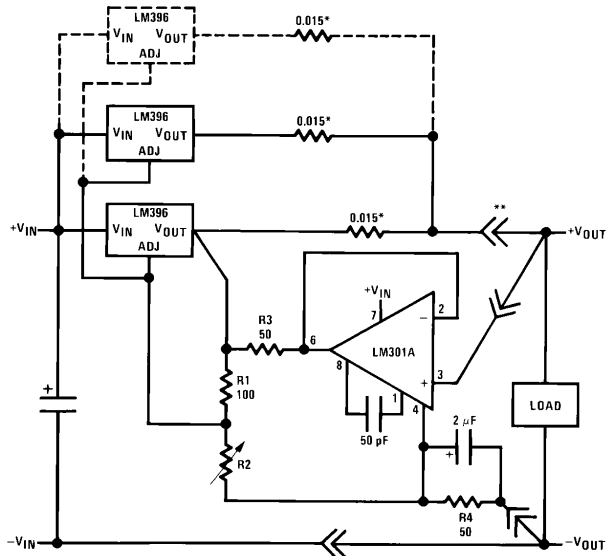

TL/H/9059-13

\*2 feet of #18 CU wire

\*\*Total voltage drop across output wire and connector should not exceed 0.3V

FIGURE 5b

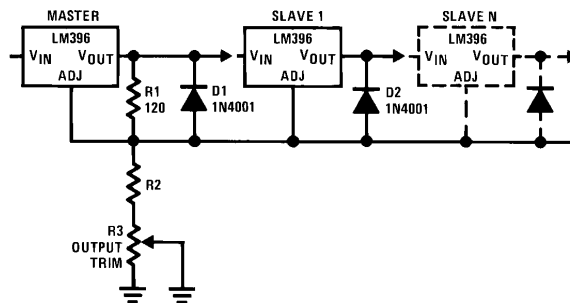

TL/H/9059-14

Output will be within  $\pm 20$  mV at  $25^\circ\text{C}$ , no load. Regulation of tracking units is improved by  $V_{\text{OUT}}/1.25$  compared to a normal connection. Regulation of master unit is unchanged. Load or input voltage changes on slave units do not affect other units, but all units will be affected by changes on master. A short on any output will cause all other outputs to drop to approximately 2V.

FIGURE 6. Tracking Regulators

## Typical Applications (Continued)

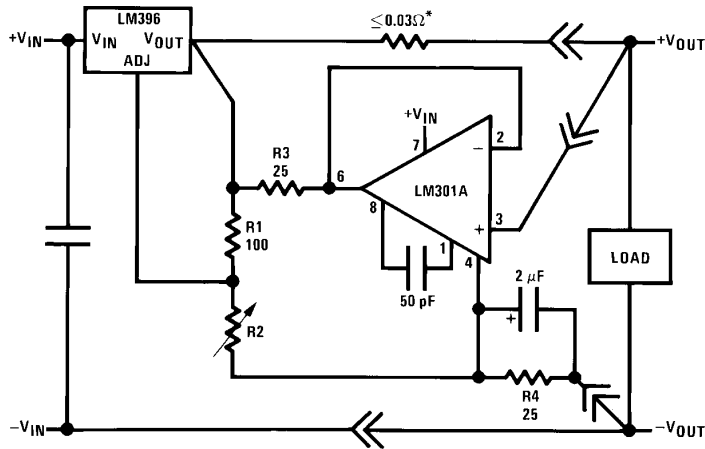

TL/H/9059-15

\*Parasitic line resistance created by wiring connectors, or parallel ballasting.

**FIGURE 7. Correcting for Line Losses**

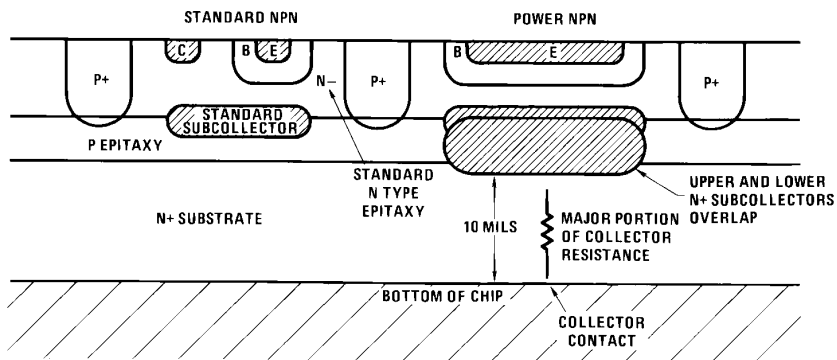

TL/H/9059-16

Power NPNs have low collector resistance, and do not require collector bond wires. Collectors are all common to substrate. Standard NPNs are still isolated.

**FIGURE 8. Process Technology**

## Connection Diagram

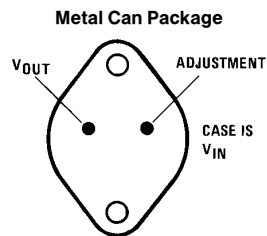

TL/H/9059-18

**Bottom View**

**Order Number LM196K STEEL or LM396K STEEL  
See NS Package Number K02B**

# Schematic Diagram \*

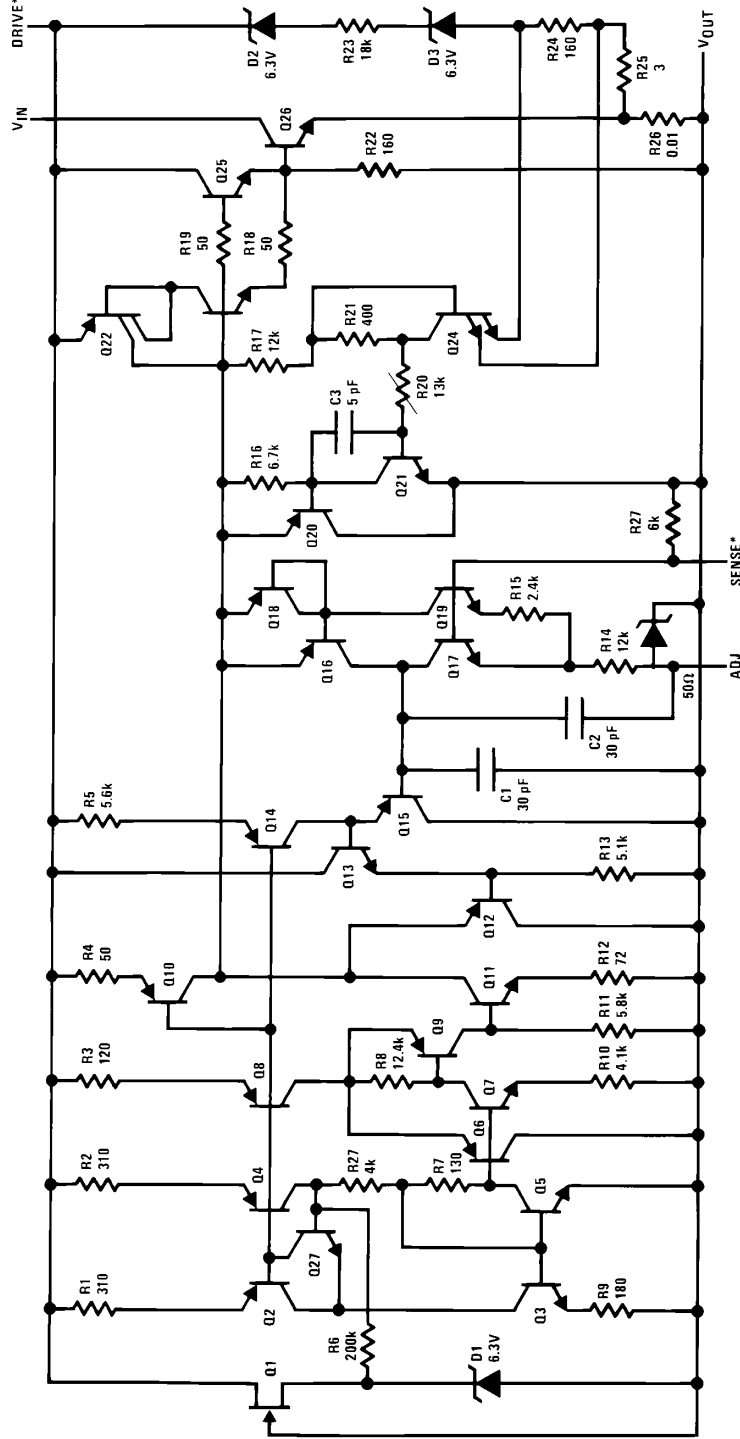

TL/H/9059-17

\*Drive is tied to VIN and sense is tied to VOUT on LM196 and LM396.



**LM196/LM396 10 Amp Adjustable Voltage Regulator**

**Physical Dimensions** inches (millimeters)

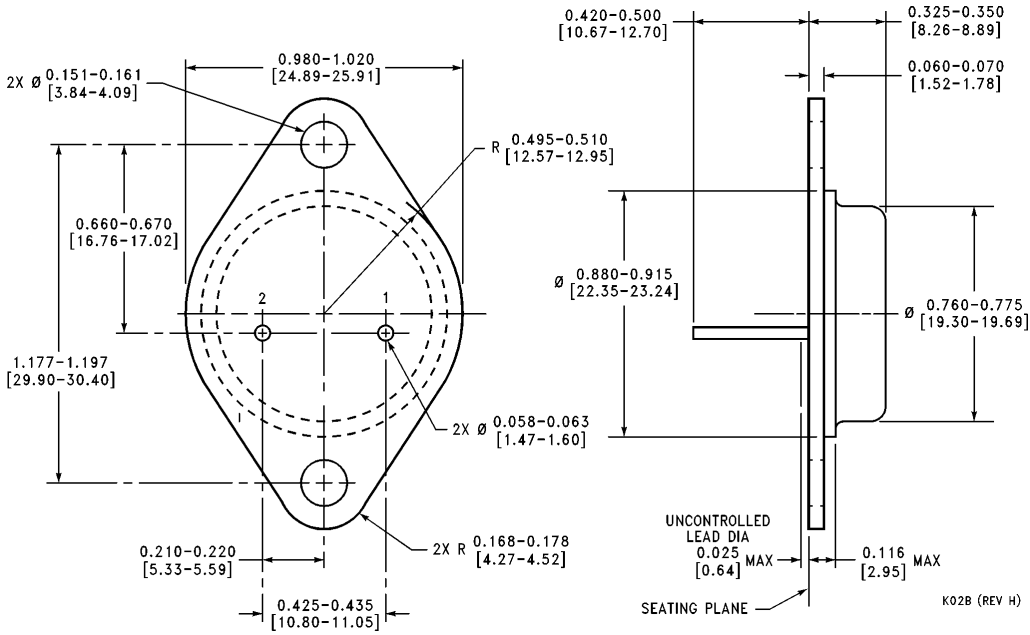

**TO-3 Metal Can Package (K)**  
**Order Number LM196K STEEL**  
**or LM396K STEEL**  
**NS Package Number K02B**

**LIFE SUPPORT POLICY**

NATIONAL'S PRODUCTS ARE NOT AUTHORIZED FOR USE AS CRITICAL COMPONENTS IN LIFE SUPPORT DEVICES OR SYSTEMS WITHOUT THE EXPRESS WRITTEN APPROVAL OF THE PRESIDENT OF NATIONAL SEMICONDUCTOR CORPORATION. As used herein:

1. Life support devices or systems are devices or systems which, (a) are intended for surgical implant into the body, or (b) support or sustain life, and whose failure to perform, when properly used in accordance with instructions for use provided in the labeling, can be reasonably expected to result in a significant injury to the user.
2. A critical component is any component of a life support device or system whose failure to perform can be reasonably expected to cause the failure of the life support device or system, or to affect its safety or effectiveness.



**National Semiconductor Corporation**  
 1111 West Bardin Road  
 Arlington, TX 76017  
 Tel: 1(800) 272-9959  
 Fax: 1(800) 737-7018

**National Semiconductor Europe**  
 Fax: (+49) 0-180-530 85 86  
 Email: cnjwge@tevm2.nsc.com  
 Deutsch Tel: (+49) 0-180-530 85 85  
 English Tel: (+49) 0-180-532 78 32  
 Français Tel: (+49) 0-180-532 93 58  
 Italiano Tel: (+49) 0-180-534 16 80

**National Semiconductor Hong Kong Ltd.**  
 19th Floor, Straight Block,  
 Ocean Centre, 5 Canton Rd.  
 Tsimshatsui, Kowloon  
 Hong Kong  
 Tel: (852) 2737-1600  
 Fax: (852) 2736-9960

**National Semiconductor Japan Ltd.**  
 Tel: 81-043-299-2309  
 Fax: 81-043-299-2408

National does not assume any responsibility for use of any circuitry described, no circuit patent licenses are implied and National reserves the right at any time without notice to change said circuitry and specifications.