

**VIDEO & SOUND IF SYSTEM
WITH VIDEO AND SOUND SWITCHES**

- 3 STAGE IF GAIN CONTROLLED AMPLIFIER
- SYNCHRONOUS VIDEO DEMODULATOR
- TOP SYNC AGC CIRCUIT
- WHITE AND BLACK NOISE INVERTER
- TUNER AGC OUTPUT FOR PNP TUNERS
(suitable also for MOSFET tuners)
- ANALOG AFC
- FM DETECTOR
- AUDIO AND VIDEO SWITCHES COMPATIBLE WITH SCART EUROPEAN NORM
- DC VOLUME CONTROL
- MUTE FUNCTION

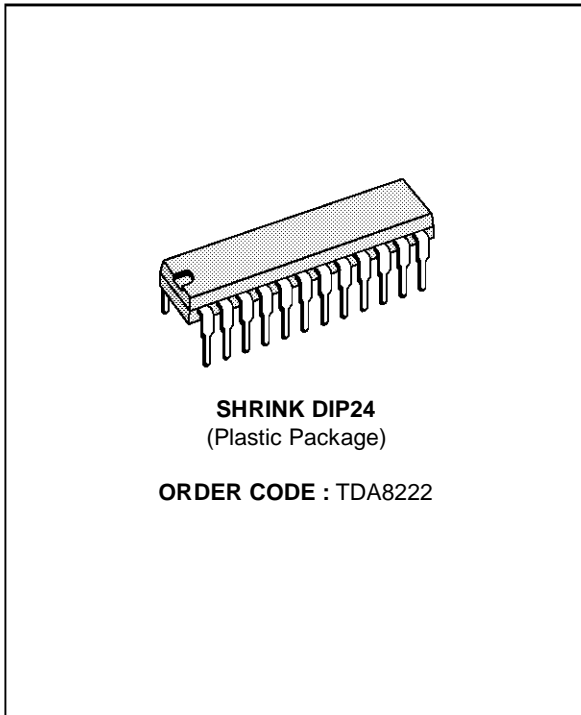

DESCRIPTION

The TDA8222 is a video and sound IF circuit in Shrink DIP24 package for color and black and white TV sets. It is intended to operate with a negatively modulated vision carrier and frequency modulated sound carrier. It incorporates video and audio switches compatible with SCART european norm.

PIN CONNECTIONS

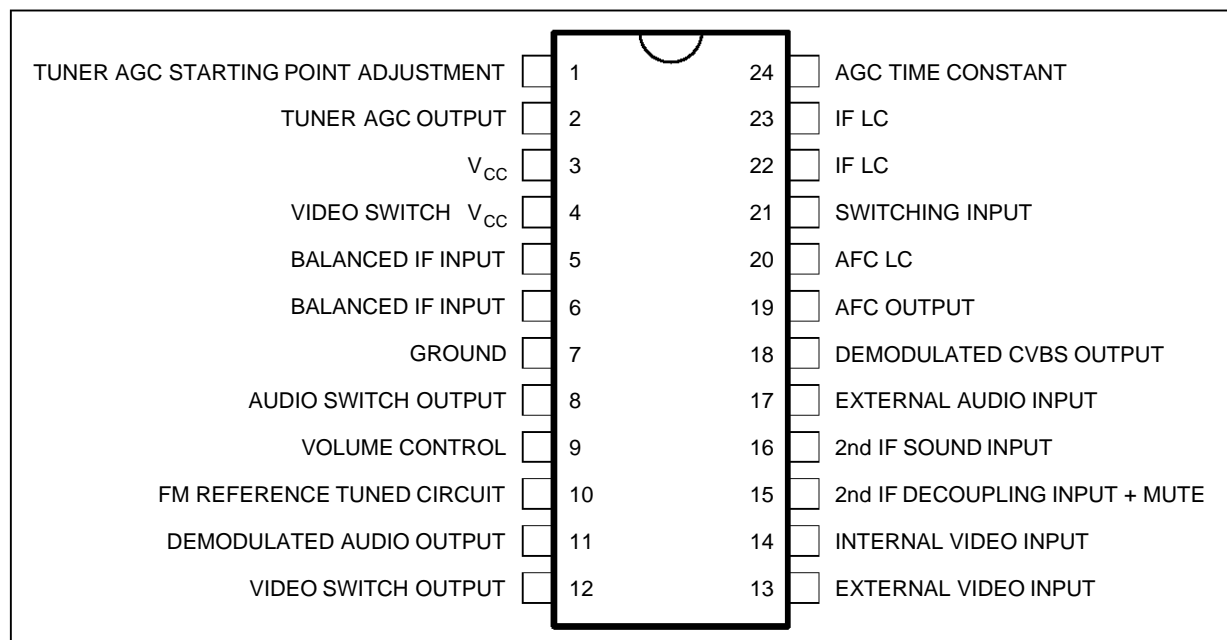

8222-01.EPS

BLOCK DIAGRAM

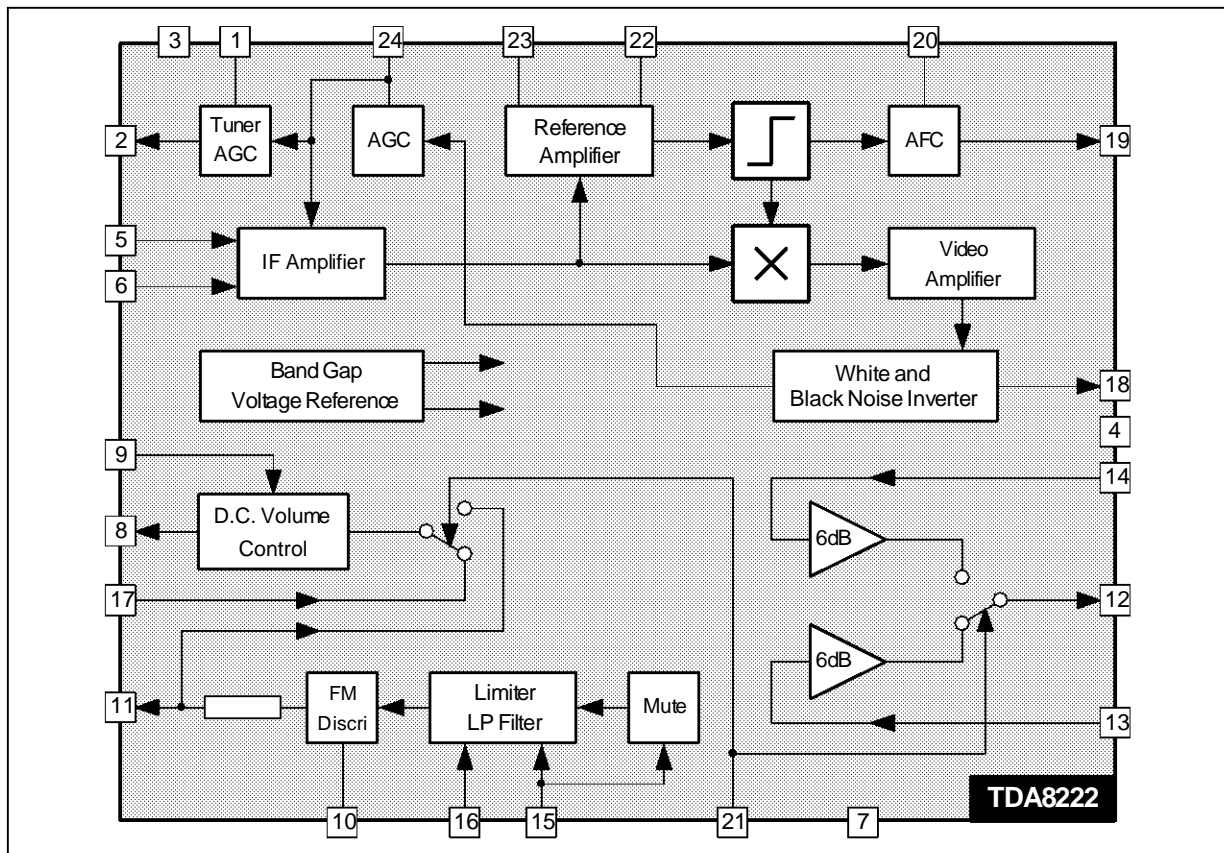

8222-09.EPS

FUNCTIONAL DESCRIPTION

General

The IC consists of the following parts (see block diagram):

- Three stages gain controlled wide band amplifier
- Quasi-synchronous demodulator
- Video amplifier with white and black noise inverter
- AGC circuit which operates on top sync level
- Analog AFC circuit
- FM discriminator
- Mute function
- Video and audio switches
- DC volume control

IF Amplifier

It consists of three cascaded AC coupled differential gain stages. The gain of each amplifier is controlled by the AGC voltage. The global AGC range is more than 60dB. Thanks to the internal AC coupling no DC feedback is required.

Demodulation

It is a quasi-synchronous type with passive carrier

regeneration done by an external tuned circuit, and a limiter amplifier.

Video Amplifier

The video amplifier provides a $2V_{PP}$ video signal to the output with a good phase and amplitude frequency response.

White and Black Noise Inverter

A fixed 3.2V level is inserted when a white spot above 4.5V (measured on the video output Pin 18) happens, this prevents from very noisy signal on the screen.

A fixed 2.5V level is inserted when a black spot below 1.3V happens, this to avoid synchronization on parasitic signals.

AGC Circuit

The AGC detector operates on top sync level, an external capacitor on Pin 24 controls the time constant.

The voltage on this capacitor is converted into a current to control the amplifier stage.

Tuner AGC

It sinks a current to control the gain of the tuner RF amplifier. Its starting point is adjusted by an external potentiometer (Pin 1).

AFC Circuit

It is a FM demodulator stage which delivers on Pin 19 a current proportional to the frequency difference between the IF input signal and the reference IF frequency of the external LC on Pin 20. This current is converted into a voltage by means of a resistor network.

FM Demodulation

It consists of a three stage limiter amplifier in order to reject the amplitude modulation and a quadrature demodulator. The deemphasis filter is built with an internal resistor and an external capacitor on Pin 11.

Mute Function

It is an internal switch to cut-off the internal audio signal. It acts when a level below 2.1V is applied on Pin 15. When no mute, the Pin 15 must be driven with a high DC impedance.

Video and Audio Switches

They are both controlled by the Pin 21 voltage.

Internal sources or external sources can be sent to the outputs (Pin 12 for video and Pin 8 for audio). The internal signals are selected by a control level below 2.5V on Pin 21, the external ones by a control level above 5V.

The gain of the video switch is 6dB for both internal and external signals.

The gain of the audio switch is 0dB for the maximum volume.

ABSOLUTE MAXIMUM RATINGS

Symbol	Parameter	Value	Unit
V_S	Supply Voltage	13.5	V
V_X	Tuner AGC Voltage	V_{CC}	V
T_{stg}	Storage Temperature	-40, +150	°C
T_{oper}	Operating Temperature	0, +70	°C

8222-01.TBL

THERMAL DATA

Symbol	Parameter	Value	Unit
$R_{th(j-a)}$	Junction-ambient Thermal Resistance	Max. 75	°C/W

8222-02.TBL

ELECTRICAL CHARACTERISTICS

($T_{amb} = 25^{\circ}\text{C}$, $V_{CC} = 9\text{V}$, IF input = 10mV_{RMS} top sync, $D = 90\%$, Video BW = 5MHz, Sound carrier input : 5.5MHz, 10mV_{RMS} , $f_m = 1\text{kHz}$, Audio BW = 20kHz, $\Delta f = \pm 25\text{kHz}$, Volume attenuation = 0dB, R_{load} on Pin 12 = $1\text{k}\Omega$, unless otherwise specified)

Symbol	Parameter	Test Conditions	Min.	Typ.	Max.	Unit
--------	-----------	-----------------	------	------	------	------

SUPPLY

V_{CC}	Voltage Operating Range		8.1	9	12.6	V
I_{CC}	Supply Current	$I(3) + I(4)$, $V_{CC} = 9\text{V}$	24	38	52	mA

IF AMPLIFIER

	Input Sensitivity	Refer to test circuit		70		μV
R_{22-23}	Differential Input Resistance			1.5		$\text{k}\Omega$
C_{22-23}	Differential Input Capacitance			2		pF
G_R	Gain Control Range			64		dB

DEMODULATED VIDEO OUTPUT (Pin 18)

V_{A18}	Amplitude	Top sync to white	1.8	2.1	2.4	V_{PP}
V_{S18}	Top Sync Level	without output filter	1.6	1.9	2.2	V
BW	Bandwidth	See Figure 1	5	7		MHz

8222-03.TBL

ELECTRICAL CHARACTERISTICS (continued)

($T_{amb} = 25^{\circ}C$, $V_{CC} = 9V$, IF input = $10mV_{RMS}$ top sync, $D = 90\%$, Video BW = 5MHz,
 Sound carrier input : 5.5MHz, $10mV_{RMS}$, $f_m = 1kHz$, Audio BW = 20kHz, $\Delta f = \pm 25kHz$,
 Volume attenuation = 0dB, R_{load} on Pin 12 = $1k\Omega$, unless otherwise specified)

Symbol	Parameter	Test Conditions	Min.	Typ.	Max.	Unit
--------	-----------	-----------------	------	------	------	------

DEMODULATED VIDEO OUTPUT (Pin 18) (continued)

D_G	Differential Gain	IF input = $5mV_{RMS}$ top sync		3	7	%
D_P	Differential Phase			3	7	Degree
V_{18}	Residual Carrier Signal (RMS value)			1	10	mV
V_{18}	Residual 2nd Harmonic (RMS value)			2	20	mV
I_{18}	Internal Bias of Emitter Follower		3	5		mA
S/N	Signal to Noise Ratio	Note 1		55		dB
	Intermodulation 1.07MHz	Note 2		50		dB
V_{WTH}	White Noise Threshold Voltage	See Figure 5		4.5		V
V_{WIL}	White Noise Insertion Level	See Figure 5		3.2		V
V_{BTH}	Black Noise Threshold Voltage			1.3		V
V_{BIL}	Black Noise Insertion Level			2.5		V

AGC CIRCUIT

I_{24C}	Charging Current		550	900	1200	μA
I_{24D}	Discharge Current		12	20	26	μA
C/D	Charging / Discharging Ratio			45		

TUNER AGC

I_2	Sinked Current		1.2	1.9	2.6	mA
S_2	Current Slope	See Figure 4		300		$\mu A/dB$

AFC

	AFC Slope	See Figure 2, refer to test circuit		20		mV/kHz
--	-----------	-------------------------------------	--	----	--	--------

FM SOUND DEMODULATION

V_{16S}	Input Sensitivity	-3dB FM detected signal		60		μV
AMR	Amplitude Modulation Rejection	Note 3	40	53		dB
R_{16}	Limiter Input Resistance			1.2		$k\Omega$

AUDIO OUTPUT (Pin 11)

V_{11}	Detected Audio Output Signal			500		mV_{RMS}
THD	Total Harmonic Distortion			0.2	1	%
$\frac{S}{N}$	Signal to Noise Ratio	Note 4		68		dB
R_{11}	Internal Deemphasis Resistor		700	1000	1400	Ω

VOLUME CONTROL

V_C range	Control Range	See Figure 3		80		dB
-------------	---------------	--------------	--	----	--	----

- Notes :
- $\frac{S}{N} = 20 \text{ Log }_{10} \frac{V_{OUT \text{ black to white}}}{V_{N(RMS)}}$ at BW = 5MHz
 - Video carrier relative level = 0dB, Chroma subcarrier relative level = -3.2dB, Sound carrier relative level = -20dB.
 - AMR = $20 \text{ Log } \frac{V_{11} (mV_{RMS})}{V_{AM} (mV_{RMS})}$ (dB) where V_{AM} = output amplitude in AM for $f_m = 1kHz$ and $m = 30\%$
 - $\frac{S}{N} = 20 \text{ Log } \frac{V_{11} (mV_{RMS})}{V_{N} (mV_{RMS})}$ (dB)

8222-04.TBL

ELECTRICAL CHARACTERISTICS (continued)

($T_{amb} = 25^{\circ}\text{C}$, $V_{CC} = 9\text{V}$, IF input = 10mV_{RMS} top sync, $D = 90\%$, Video BW = 5MHz,
 Sound carrier input : 5.5MHz, 10mV_{RMS} , $f_m = 1\text{kHz}$, Audio BW = 20kHz, $\Delta f = \pm 25\text{kHz}$,
 Volume attenuation = 0dB, R_{load} on Pin 12 = $1\text{k}\Omega$, unless otherwise specified)

Symbol	Parameter	Test Conditions	Min.	Typ.	Max.	Unit
--------	-----------	-----------------	------	------	------	------

AUDIO SWITCH

R_{17}	Input Resistance		40	65		$\text{k}\Omega$
C_{Rtk}	Crosstalk		70	80		dB
EXTHD	THD on External Signal	$V_{IN} = 2V_{\text{RMS}}$, Attenuation = 0dB		0.05	0.3	%

VIDEO SWITCH

$V_{DC\ 13-14}$	DC Input Level	No signal	1.6	1.9	2.2	V
$V_{S\ 13-14}$	Top Sync Clamp Level			1.8		V
V_{12}	DC Output Level	No signal	0.7	1.0	1.3	V
$V_{S\ 12}$	Top Sync Clamp Level			0.85		V
	Crosstalk			55		dB
$G_{13-14\ .\ 12}$	Gain from inputs to output	$V_{IN} = 1V_{\text{PP}}$	5.5	6	6.5	dB
	Output Swing		4.5			V
I_{13-14}	Input Current	$V_{13-14} = V_{DC\ 13-14} + 1.5\text{V}$		1	5	μA
VBW	Bandwidth	$V_{IN} = 1V_{\text{PP}}$		15		MHz

SWITCHING INPUT

$V_{21\ ext}$	External Input Selection Level		5			V
$V_{21\ int}$	Internal Input Selection Level				2.5	
I_{21}	Sourced Current		0		10	μA

MUTE

V_{15}	Threshold Voltage			2.1		V
V_{15}	DC Level when mute disabled	High impedance controlling circuit		2.8		V

8222-05.TBL

TEST CIRCUIT

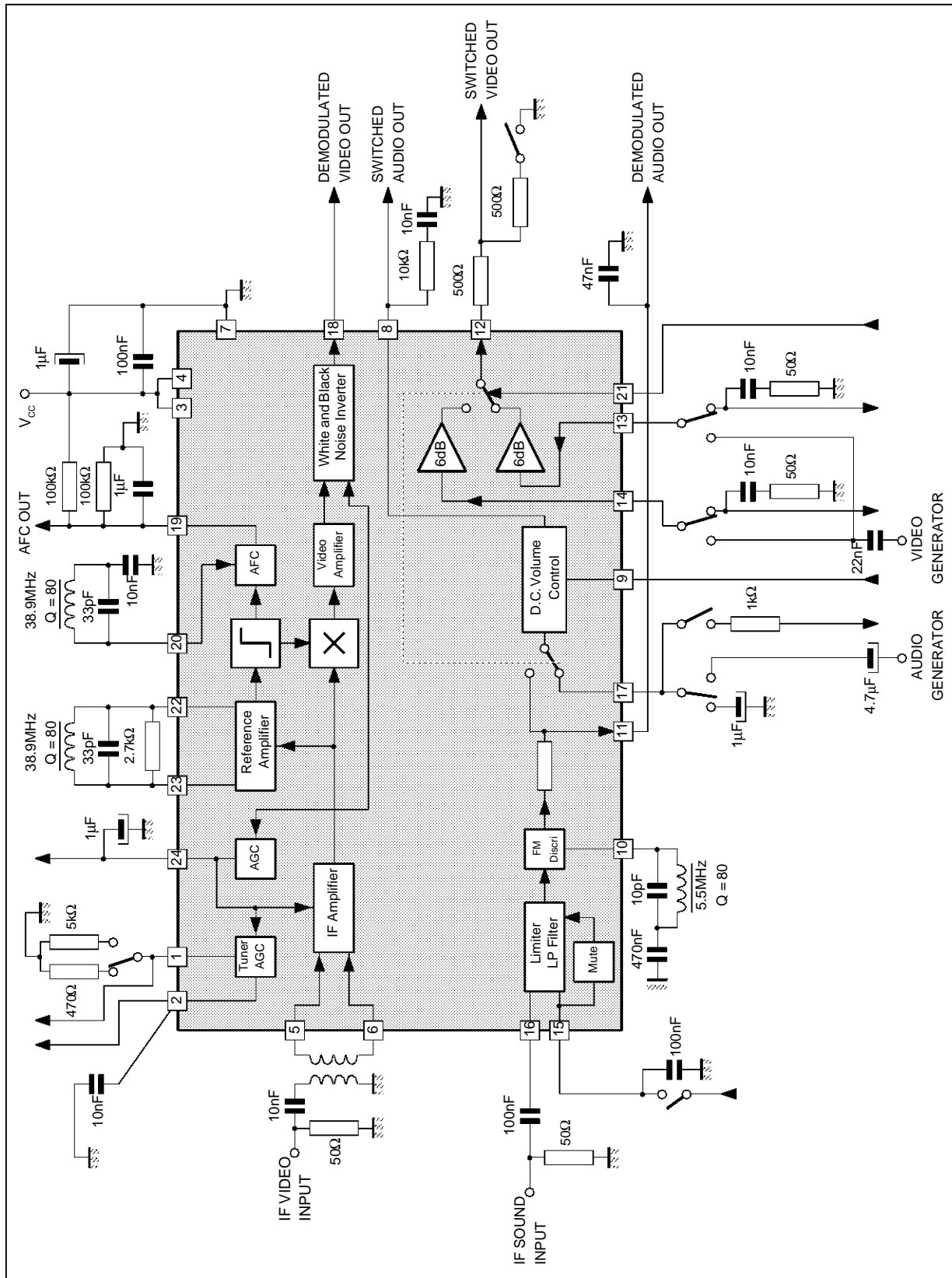

8222-03.EPS

Figure 1 : Output Signal Bandwidth on Pin 18

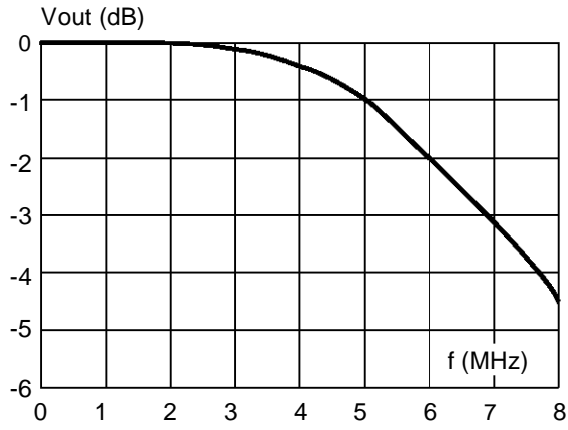

Figure 2 : AFC Voltage versus Input Frequency on Pin 19

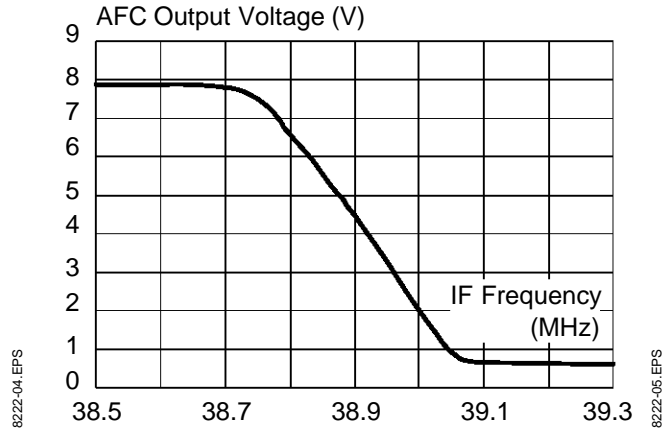

Figure 3 : Volume Control Attenuation versus Voltage on Pin 9

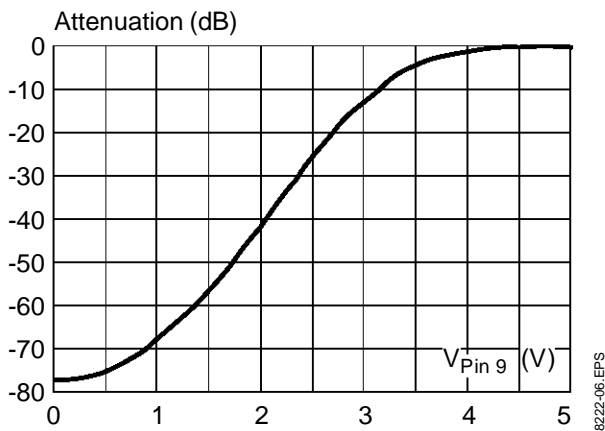

Figure 4 : Tuner AGC Output Current on Pin 2

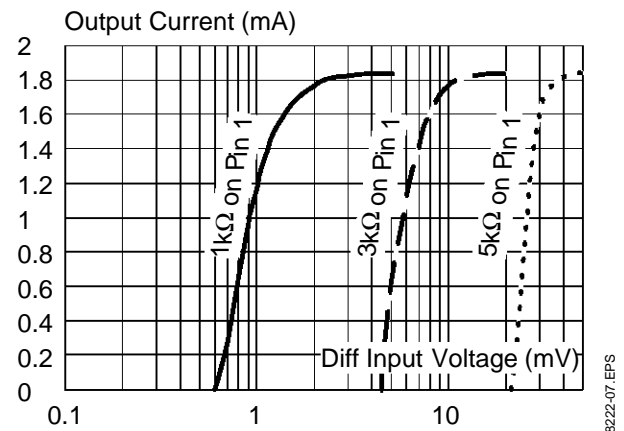
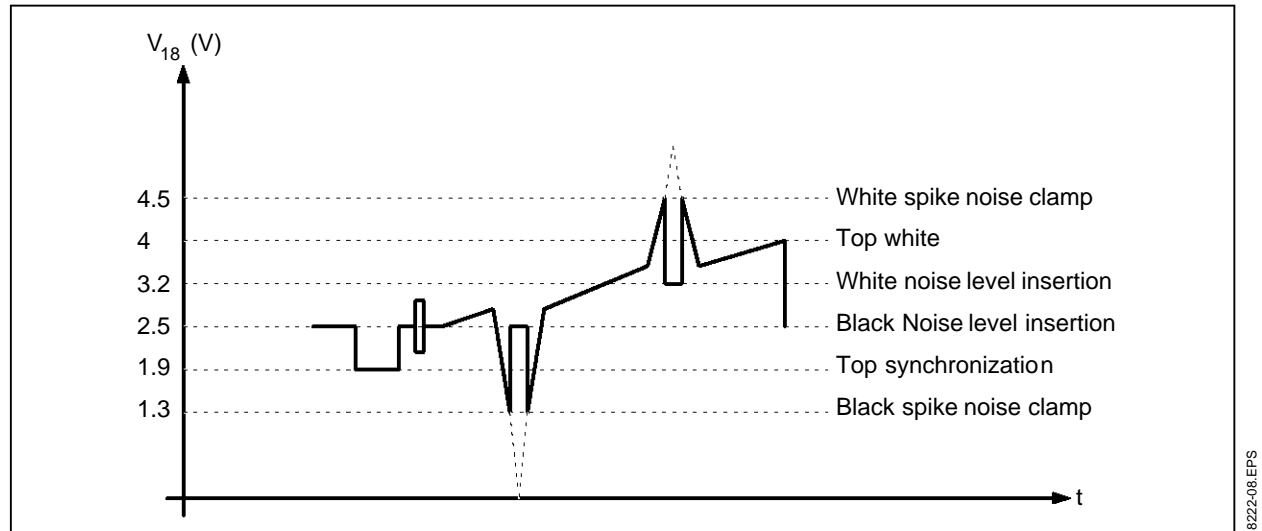
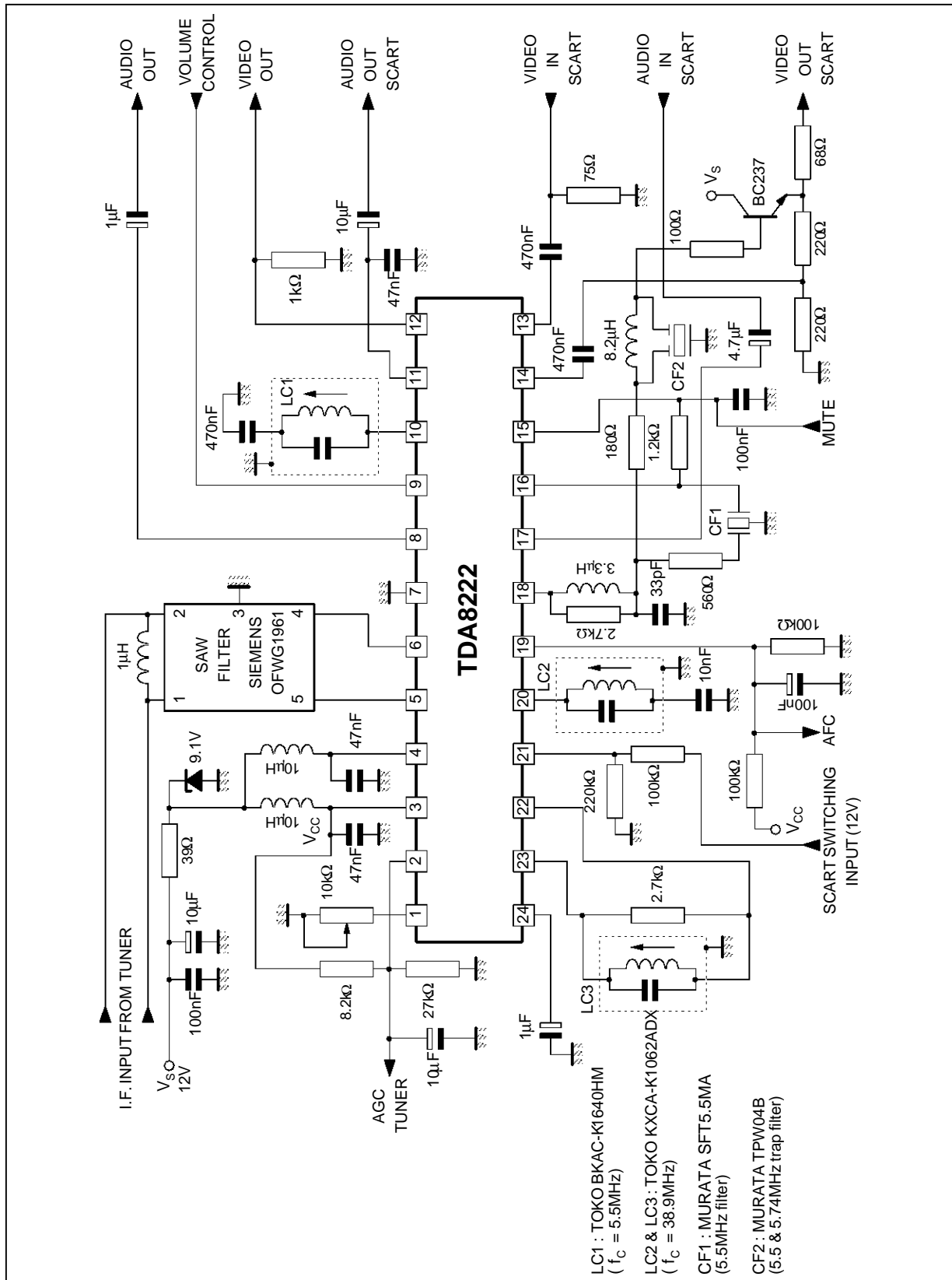

Figure 5 : Black and White Noise Inverter



TYPICAL APPLICATION (for B/G standard)



8222-09/EP5

PACKAGE MECHANICAL DATA
24 PINS - PLASTIC SHRINK

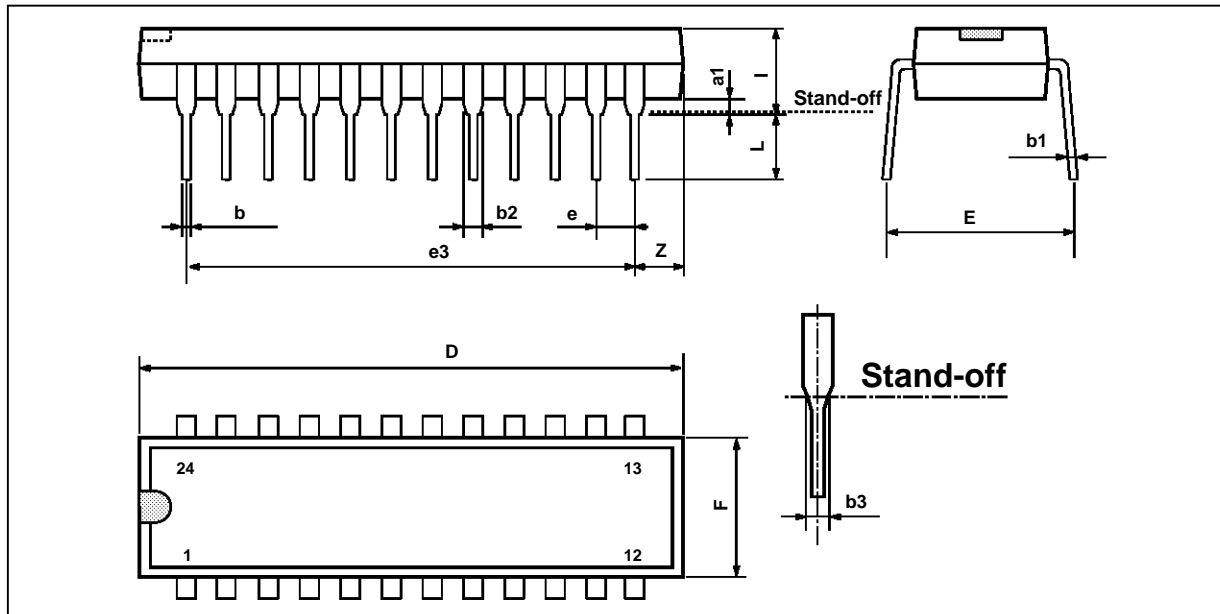

PMSDIP24.EPS

Dimensions	Millimeters			Inches		
	Min.	Typ.	Max.	Min.	Typ.	Max.
A		3.3			0.130	
a1	0.51			0.020		
b	0.35		0.59	0.014		0.023
b1	0.2		0.36	0.008		0.014
b2	0.75		1.42	0.030		0.056
b3	0.75			0.030		
D			23.11			0.910
E	7.95		9.73	0.313		0.383
e		1.778			0.070	
e3		19.558			0.770	
e4		7.62			0.300	
F			6.86			0.270
i			5.08			0.200
L	2.54			0.100		

SDIP24.TBL

Information furnished is believed to be accurate and reliable. However, SGS-THOMSON Microelectronics assumes no responsibility for the consequences of use of such information nor for any infringement of patents or other rights of third parties which may result from its use. No licence is granted by implication or otherwise under any patent or patent rights of SGS-THOMSON Microelectronics. Specifications mentioned in this publication are subject to change without notice. This publication supersedes and replaces all information previously supplied. SGS-THOMSON Microelectronics products are not authorized for use as critical components in life support devices or systems without express written approval of SGS-THOMSON Microelectronics.

© 1994 SGS-THOMSON Microelectronics - All Rights Reserved

Purchase of I²C Components of SGS-THOMSON Microelectronics, conveys a license under the Philips I²C Patent. Rights to use these components in a I²C system, is granted provided that the system conforms to the I²C Standard Specifications as defined by Philips.

SGS-THOMSON Microelectronics GROUP OF COMPANIES

Australia - Brazil - China - France - Germany - Hong Kong - Italy - Japan - Korea - Malaysia - Malta - Morocco
The Netherlands - Singapore - Spain - Sweden - Switzerland - Taiwan - Thailand - United Kingdom - U.S.A.