

# DATA SHEET

## **TDA7053A**

**Stereo BTL audio output amplifier  
with DC volume control**

Objective specification  
Supersedes data of May 1995  
File under Integrated Circuits, IC01

1995 Nov 09

# Stereo BTL audio output amplifier with DC volume control

## TDA7053A

### FEATURES

- DC volume control
- Few external components
- Mute mode
- Thermal protection
- Short-circuit proof
- No switch-on and switch-off clicks
- Good overall stability
- Low power consumption
- Low HF radiation
- ESD protected on all pins.

### GENERAL DESCRIPTION

The TDA7053A ( $2 \times 1$  W) and TDA7053AT ( $2 \times 0.5$  W) are stereo BTL output amplifiers with DC volume control. The devices are designed for use in TV and monitors, but are also suitable for battery-fed portable recorders and radios.

### Missing Current Limiter (MCL)

A MCL protection circuit is built-in. The MCL circuit is activated when the difference in current between the output terminal of each amplifier exceeds 100 mA (typical 300 mA). This level of 100 mA allows for headphone applications (single-ended).

### QUICK REFERENCE DATA

SYMBOL	PARAMETER	CONDITIONS	MIN.	TYP.	MAX.	UNIT
$V_P$	supply voltage		4.5	–	18	V
$P_{out}$	output power	$V_P = 6$ V				
	TDA7053A	$R_L = 8 \Omega$	0.85	1.0	–	W
	TDA7053AT	$R_L = 16 \Omega$	0.5	0.6	–	W
$G_v$	voltage gain		39.5	40.5	41.5	dB
$G_C$	gain control		68.0	73.5	–	dB
$I_{q(tot)}$	total quiescent current	$V_P = 6$ V; $R_L = \infty$	–	22	25	mA
THD	total harmonic distortion					
	TDA7053A	$P_{out} = 0.5$ W	–	0.3	1	%
	TDA7053AT	$P_{out} = 0.25$ W	–	0.3	1	%

### ORDERING INFORMATION

TYPE NUMBER	PACKAGE		
	NAME	DESCRIPTION	VERSION
TDA7053A	DIP16	plastic dual in-line package; 16 leads (300 mil); long body	SOT38-1
TDA7053AT	SO16	plastic small outline package; 16 leads; body width 7.5 mm	SOT162-1

Stereo BTL audio output amplifier with DC volume control

TDA7053A

BLOCK DIAGRAM

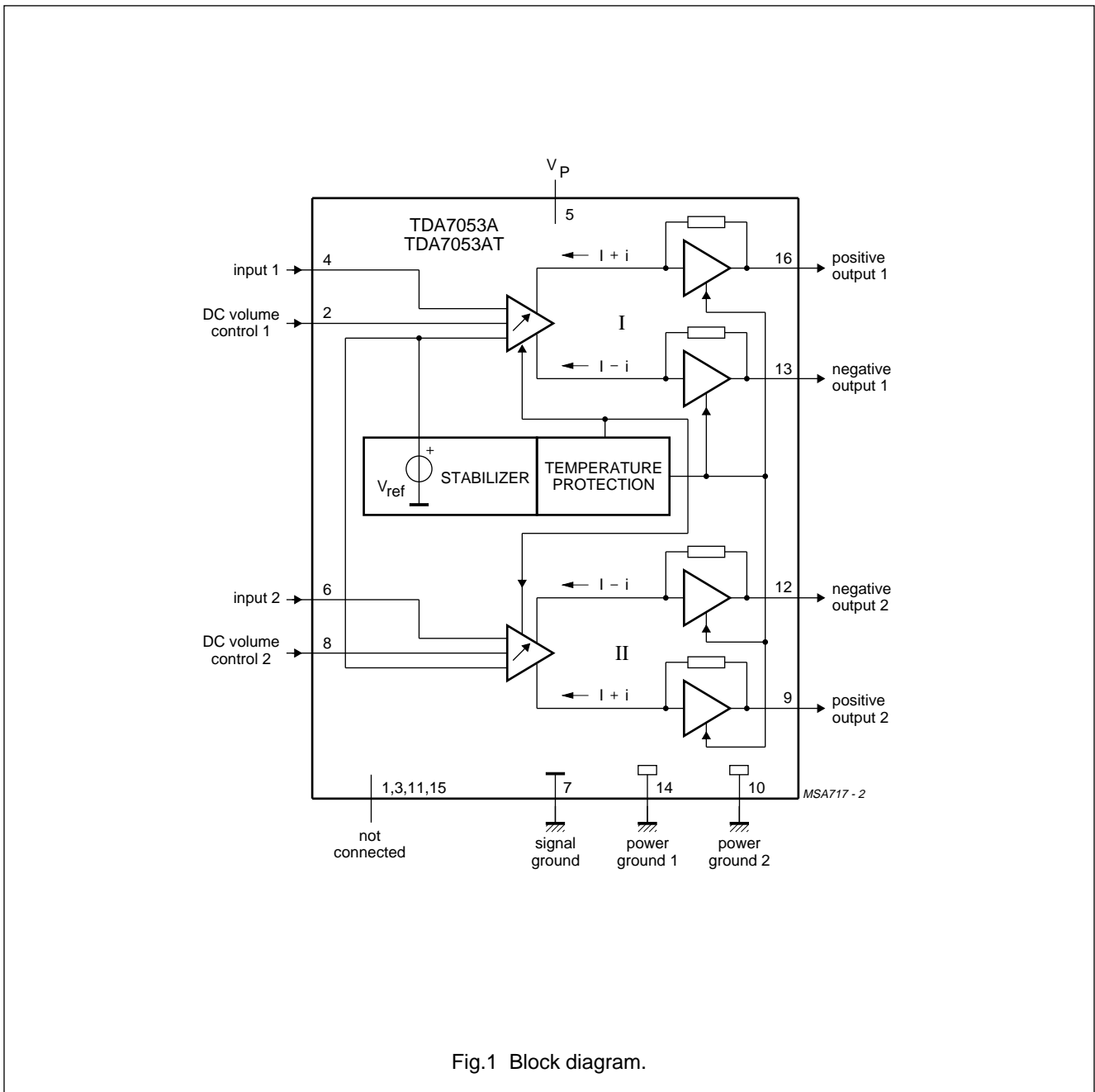

Fig.1 Block diagram.

# Stereo BTL audio output amplifier with DC volume control

TDA7053A

## PINNING

SYMBOL	PIN	DESCRIPTION
n.c.	1	not connected
VC1	2	DC volume control 1
n.c.	3	not connected
$V_{I(1)}$	4	voltage input 1
$V_P$	5	positive supply voltage
$V_{I(2)}$	6	voltage input 2
SGND	7	signal ground
VC2	8	DC volume control 2
OUT2+	9	positive output 2
PGND2	10	power ground 2
n.c.	11	not connected
OUT2-	12	negative output 2
OUT1-	13	negative output 1
PGND1	14	power ground 1
n.c.	15	not connected
OUT1+	16	positive output 1

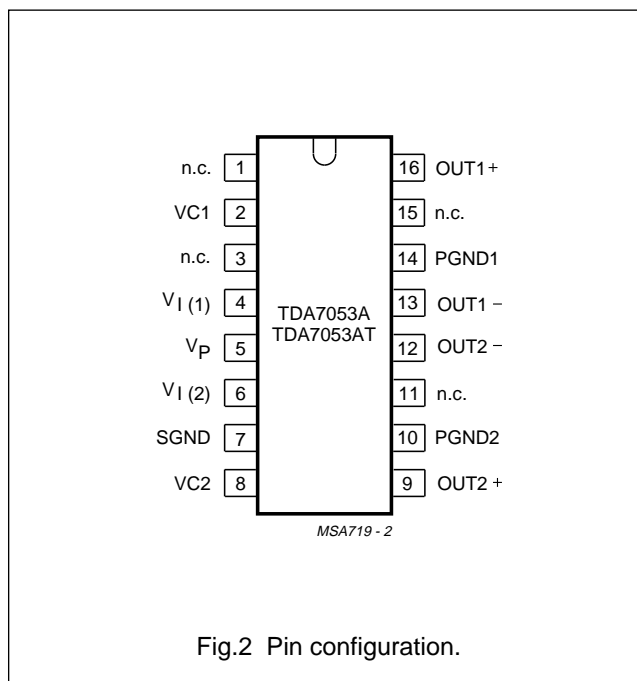

## FUNCTIONAL DESCRIPTION

The TDA7053A and TDA7053AT are stereo output amplifiers with two DC volume control stages, designed for TV and monitors, but also suitable for battery-fed portable recorders and radios.

In conventional DC volume control circuits the control or input stage is AC coupled to the output stage via external capacitors to keep the offset voltage low.

The two DC volume control stages are integrated into the input stages so that no coupling capacitors are required and a low offset voltage is still maintained. The minimum supply voltage also remains low.

The BTL principle offers the following advantages:

- Lower peak value of the supply current
- The frequency of the ripple on the supply voltage is twice the signal frequency.

Consequently, a reduced power supply with smaller capacitors can be used which results in cost reductions.

For portable applications there is a trend to decrease the supply voltage, resulting in a reduction of output power at conventional output stages. Using the BTL principle increases the output power.

The maximum gain of the amplifier is fixed at 40.5 dB. The DC volume control stages have a logarithmic control characteristic. Therefore, the total gain can be controlled from +40.5 to -33 dB.

If the DC volume control voltage falls below 0.4 V, the device will switch to the mute mode.

The amplifier is short-circuit protected to ground,  $V_P$  and across the load. A thermal protection circuit is also implemented. If the crystal temperature rises above 150 °C the gain will be reduced, thereby reducing the output power.

Special attention is given to switch-on and switch-off clicks, low HF radiation and a good overall stability.

# Stereo BTL audio output amplifier with DC volume control

TDA7053A

## LIMITING VALUES

In accordance with the Absolute Maximum Rating System (IEC 134).

SYMBOL	PARAMETER	CONDITIONS	MIN.	MAX.	UNIT
$V_P$	supply voltage		–	18	V
$I_{ORM}$	repetitive peak output current		–	1.25	A
$I_{OSM}$	non-repetitive peak output current		–	1.5	A
$P_{tot}$	total power dissipation	$T_{amb} \leq 25\text{ °C}$			
	TDA7053A		–	2.5	W
	TDA7053AT	–	1.32	W	
$t_{sc}$	short-circuit time		–	1	hr
$V_n$	input voltage pins 2, 4, 6 and 8		–	5	V
$T_{amb}$	operating ambient temperature		–40	+85	°C
$T_{stg}$	storage temperature		–55	+150	°C
$T_{vj}$	virtual junction temperature		–	+150	°C

## THERMAL CHARACTERISTICS

SYMBOL	PARAMETER	VALUE	UNIT
$R_{th\ j-a}$	thermal resistance from junction to ambient in free air		
	TDA7053A	50	K/W
	TDA7053AT	95	K/W

### Power dissipation

TDA7053A:

Assume  $V_P = 6\text{ V}$  and  $R_L = 8\ \Omega$ .

The maximum sine wave dissipation is  $2 \times 0.9\text{ W} = 1.8\text{ W}$ .

The  $R_{th\ j-a}$  of the package is 50 K/W therefore  $T_{amb(max)} = 150 - (50 \times 1.8) = 60\text{ °C}$ .

TDA7053AT:

Assume  $V_P = 6\text{ V}$  and  $R_L = 16\ \Omega$ .

The maximum sine wave dissipation is  $2 \times 0.46\text{ W} = 0.92\text{ W}$ .

The  $R_{th\ j-a}$  of the package is 95 K/W therefore  $T_{amb(max)} = 150 - (95 \times 0.92) = 62.6\text{ °C}$ .

# Stereo BTL audio output amplifier with DC volume control

TDA7053A

## CHARACTERISTICS

$V_P = 6\text{ V}$ ;  $T_{\text{amb}} = 25\text{ }^\circ\text{C}$ ;  $f_i = 1\text{ kHz}$ ; TDA7053A:  $R_L = 8\ \Omega$ ; TDA7053AT:  $R_L = 16\ \Omega$ ; unless otherwise specified (see Fig.13).

SYMBOL	PARAMETER	CONDITIONS	MIN.	TYP.	MAX.	UNIT
$V_P$	supply voltage		4.5	–	18	V
$I_{q(\text{tot})}$	total quiescent current	$V_P = 6\text{ V}$ ; $R_L = \infty$ ; note 1	–	22	25	mA
<b>Maximum gain; <math>V_{2,8} \geq 1.4\text{ V}</math></b>						
$P_{\text{out}}$	output power	THD = 10%				
	TDA7053A		1.0	1.1	–	W
	TDA7053AT		0.5	0.6	–	W
THD	total harmonic distortion					
	TDA7053A	$P_{\text{out}} = 0.5\text{ W}$	–	0.3	1	%
	TDA7053AT	$P_{\text{out}} = 0.25\text{ W}$	–	0.3	1	%
$G_V$	voltage gain		39.5	40.5	41.5	dB
$V_{I(\text{rms})}$	input signal handling (RMS value)	$G_V = 0\text{ dB}$ ; THD < 1%	1	–	–	V
$V_{\text{no}}$	noise output voltage	$f_i = 500\text{ kHz}$ ; note 2	–	210	–	$\mu\text{V}$
B	bandwidth	at –1 dB	–	note 3	–	Hz
SVRR	supply voltage ripple rejection	note 4	34	38	–	dB
$V_{O(\text{os})}$	DC output offset voltage	$ V_{16} - V_{13} $ and $ V_{12} - V_9 $	–	0	200	mV
$Z_i$	input impedance (pins 4 and 6)		15	20	25	$\text{k}\Omega$
$\alpha_{\text{cs}}$	channel separation	$R_S = 5\text{ k}\Omega$	40	–	–	dB
$ G_V $	channel unbalance	note 5	–	–	1	dB
		$G_1 = 0\text{ dB}$ ; note 6	–	–	1	dB
<b>Mute position; <math>V_{2,8} = 0.4\text{ V} \pm 30\text{ mV}</math></b>						
$V_O$	output voltage in mute position	$V_i = 1.0\text{ V}$ ; note 7	–	–	30	$\mu\text{V}$
<b>DC volume control</b>						
$G_C$	gain control		68.5	73.5	–	dB
$I_{\text{DC}}$	volume control current	$V_2 = V_8 = 0\text{ V}$	–20	–25	–30	$\mu\text{A}$

## Notes

- With a load connected to the outputs the quiescent current will increase, the maximum value of this increase being equal to the DC output offset voltage divided by  $R_L$ .
- The noise output voltage (RMS value) at  $f_i = 500\text{ kHz}$  is measured with  $R_S = 0\ \Omega$  and bandwidth = 5 kHz.
- 20 Hz to 300 kHz (typical).
- The ripple rejection is measured with  $R_S = 0\ \Omega$  and  $f_i = 100\text{ Hz}$  to 10 kHz. The ripple voltage of 200 mV (RMS value) is applied to the positive supply rail.
- The channel unbalance is measured with  $V_{\text{DC}1} = V_{\text{DC}2}$ .
- The channel unbalance at  $G_1 = 0\text{ dB}$  is measured with  $V_{\text{DC}1} = V_{\text{DC}2}$ .
- The noise output voltage (RMS value) is measured with  $R_S = 5\text{ k}\Omega$  unweighted.

# Stereo BTL audio output amplifier with DC volume control

TDA7053A

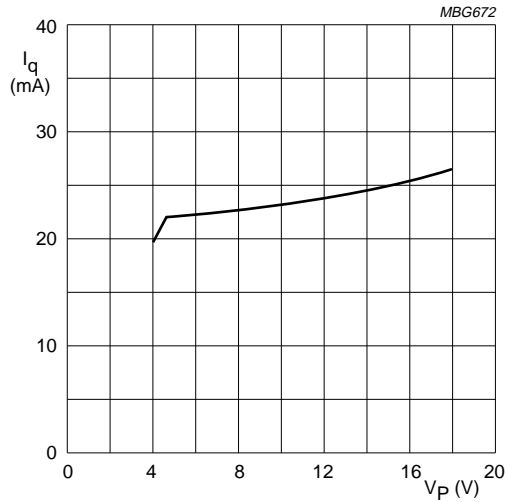
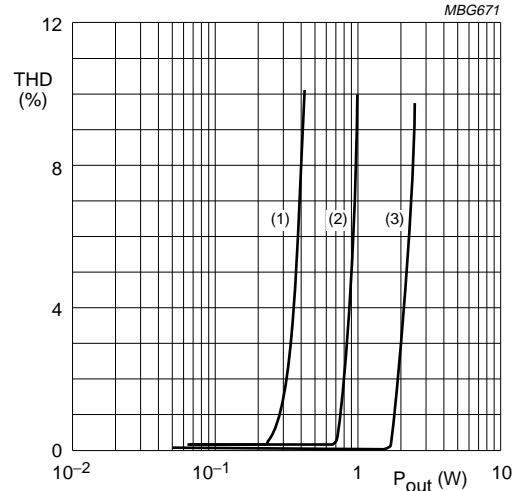
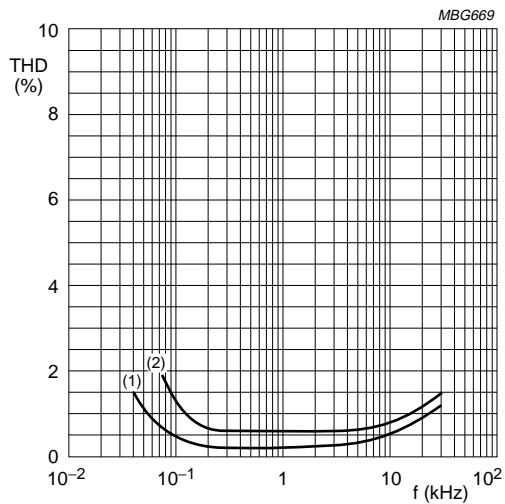

Fig.3 Quiescent current as a function of supply voltage.



- (1)  $V_P = 4.5 \text{ V}$ .
- (2)  $V_P = 6 \text{ V}; R_L = 8 \Omega$ .
- (3)  $V_P = 12 \text{ V}; R_L = 25 \Omega$ .

Fig.4 THD as a function of output power.



- (1)  $G_v = 30 \text{ dB}; P_o = 0.1 \text{ W}$ .
- (2)  $G_v = 40 \text{ dB}; P_o = 0.1 \text{ W}$ .

Fig.5 THD as a function of frequency.

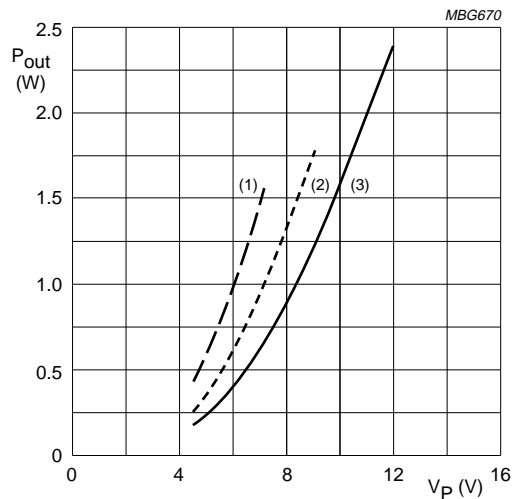

- (1)  $R_L = 8 \Omega$ .
- (2)  $R_L = 16 \Omega$ .
- (3)  $R_L = 25 \Omega$ .

Fig.6 Output power as a function of supply voltage.

# Stereo BTL audio output amplifier with DC volume control

TDA7053A

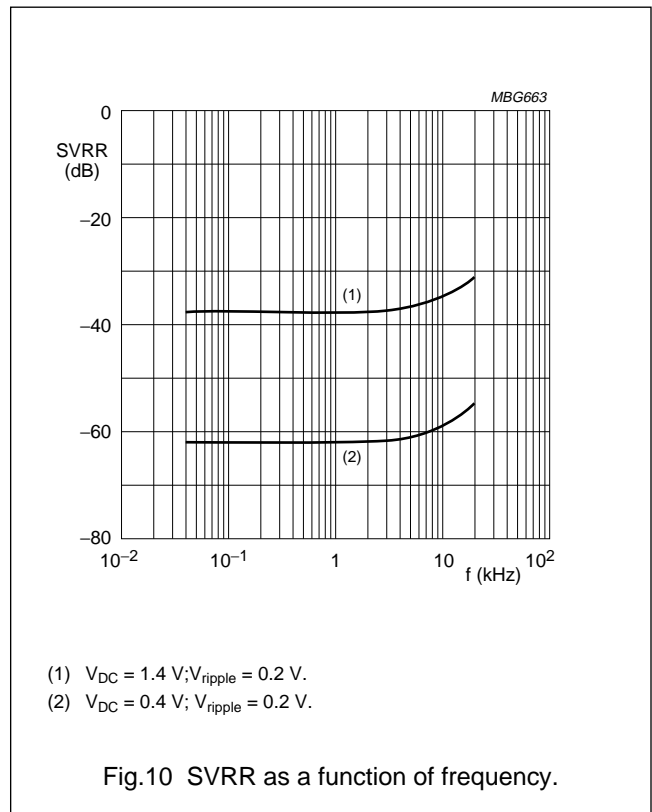
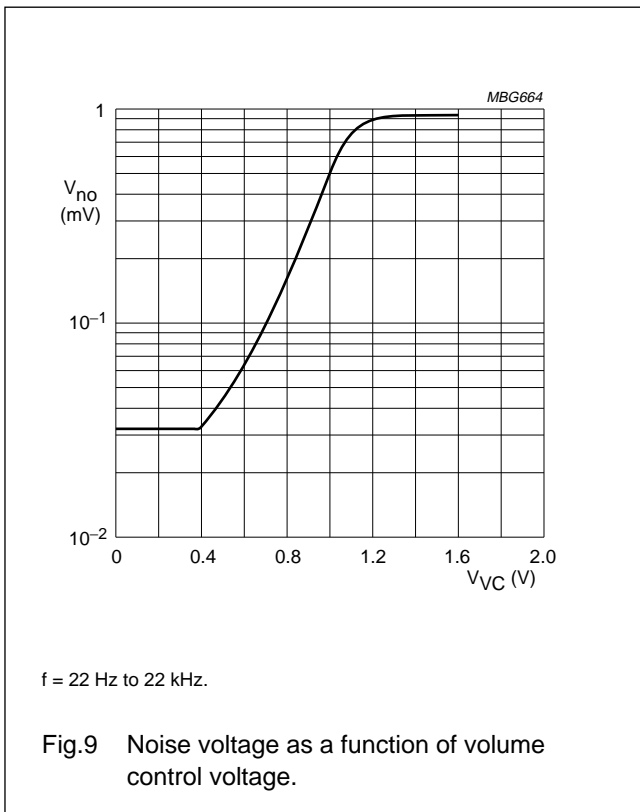
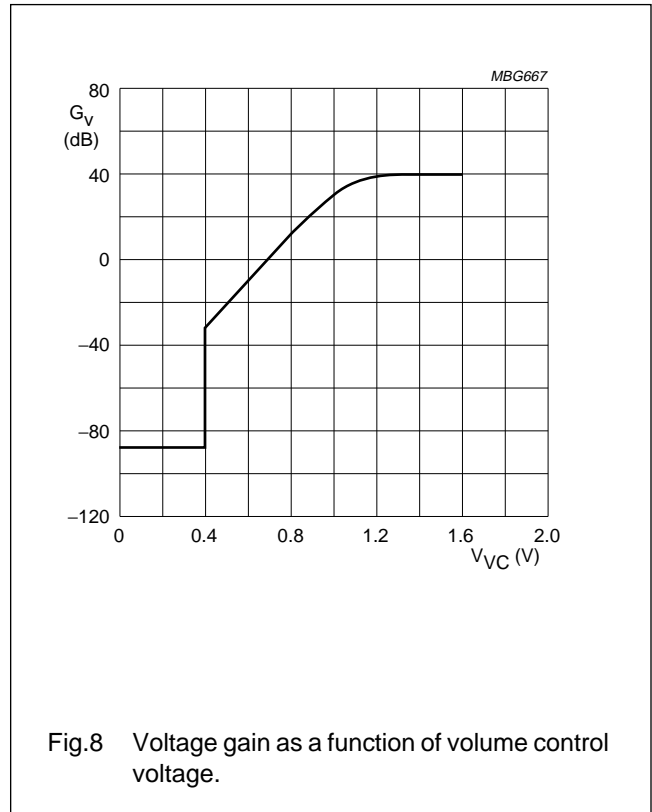
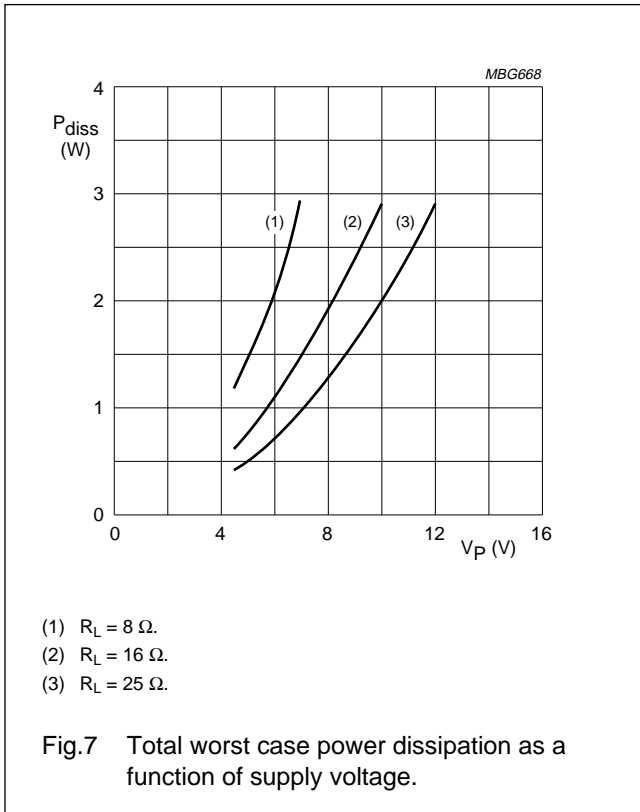



# Stereo BTL audio output amplifier with DC volume control

TDA7053A

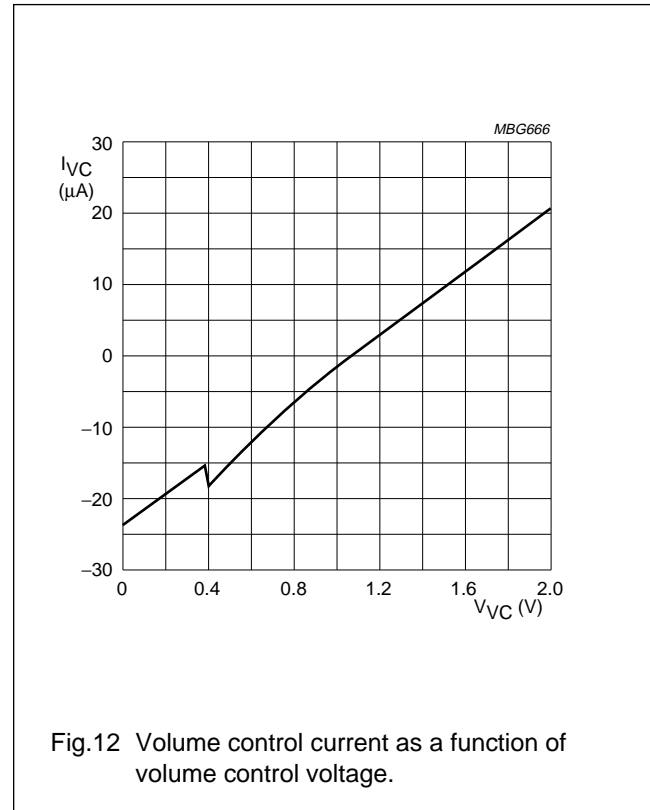
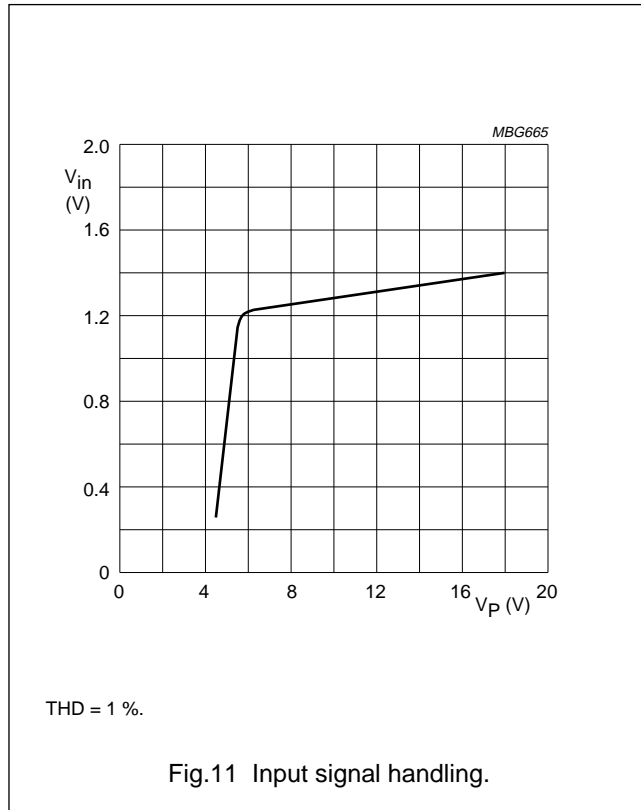

## APPLICATION INFORMATION

The application diagram is illustrated in Fig.13.

### Test conditions

$T_{amb} = 25\text{ }^{\circ}\text{C}$  unless otherwise specified;  $V_P = 6\text{ V}$ ;  
 $V_{DC} = 1.4\text{ V}$ ;  $f_i = 1\text{ kHz}$ ;  $R_L = 8\ \Omega$ .

The quiescent current has been measured without load impedance.

The output power as a function of the supply voltage has been measured at THD = 10%. The maximum output power is limited by the maximum power dissipation and the maximum available output current.

The maximum input signal voltage is measured at THD = 1% at the output with a voltage gain of 0 dB.

To avoid instabilities and too high distortion, the input ground and power ground must be separated as far as possible and connected as close as possible to the IC.

The DC volume control can be applied in several ways. Two possible circuits are shown below the main application diagram. The circuits at the control pin will influence the switch-on and switch-off behaviour and the maximum voltage gain.

For single-end applications the output peak current must not exceed 100 mA. At higher output currents the short-circuit protection (MCL) will be active.

# Stereo BTL audio output amplifier with DC volume control

TDA7053A

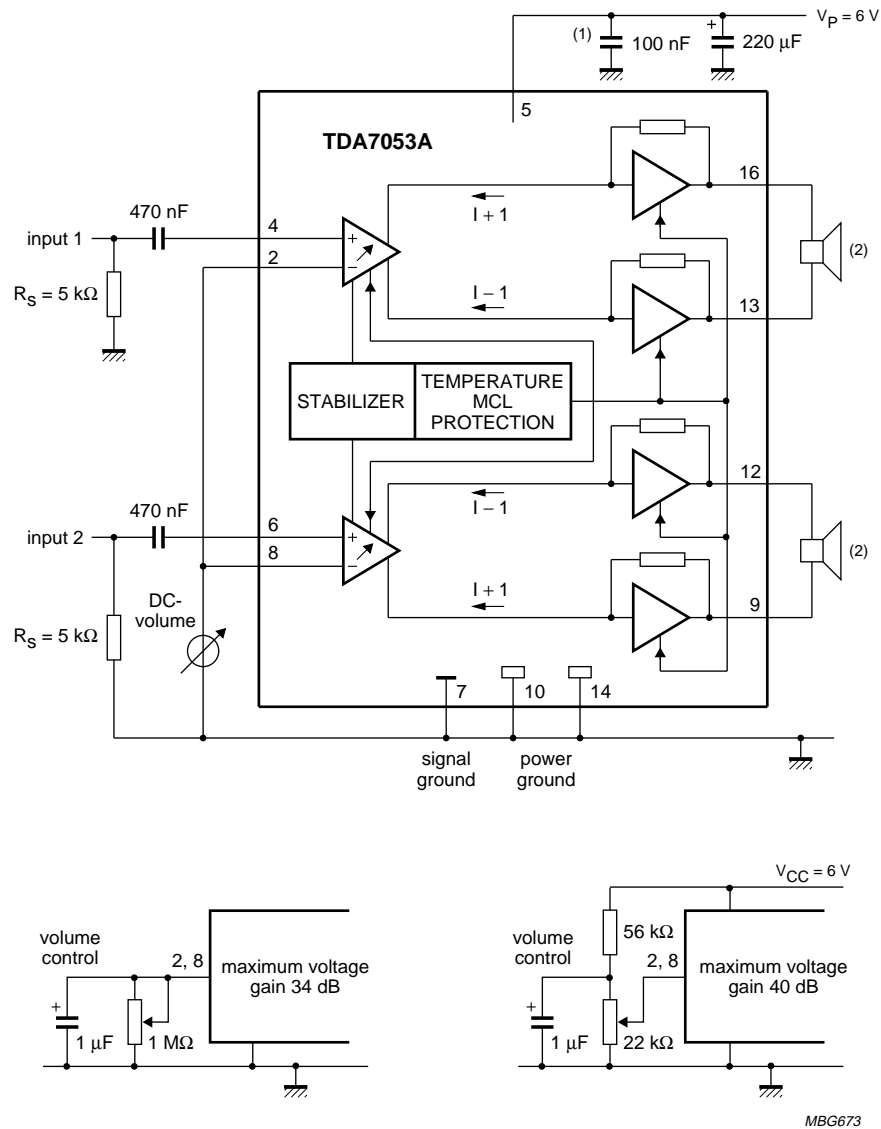

(1) This capacitor can be omitted if the 220 μF electrolytic capacitor is connected close to pin 5.  
 (2)  $R_L = 8 \Omega$ .

Fig.13 Test and application diagram.

# Stereo BTL audio output amplifier with DC volume control

TDA7053A

## PACKAGE OUTLINES

DIP16: plastic dual in-line package; 16 leads (300 mil); long body

SOT38-1

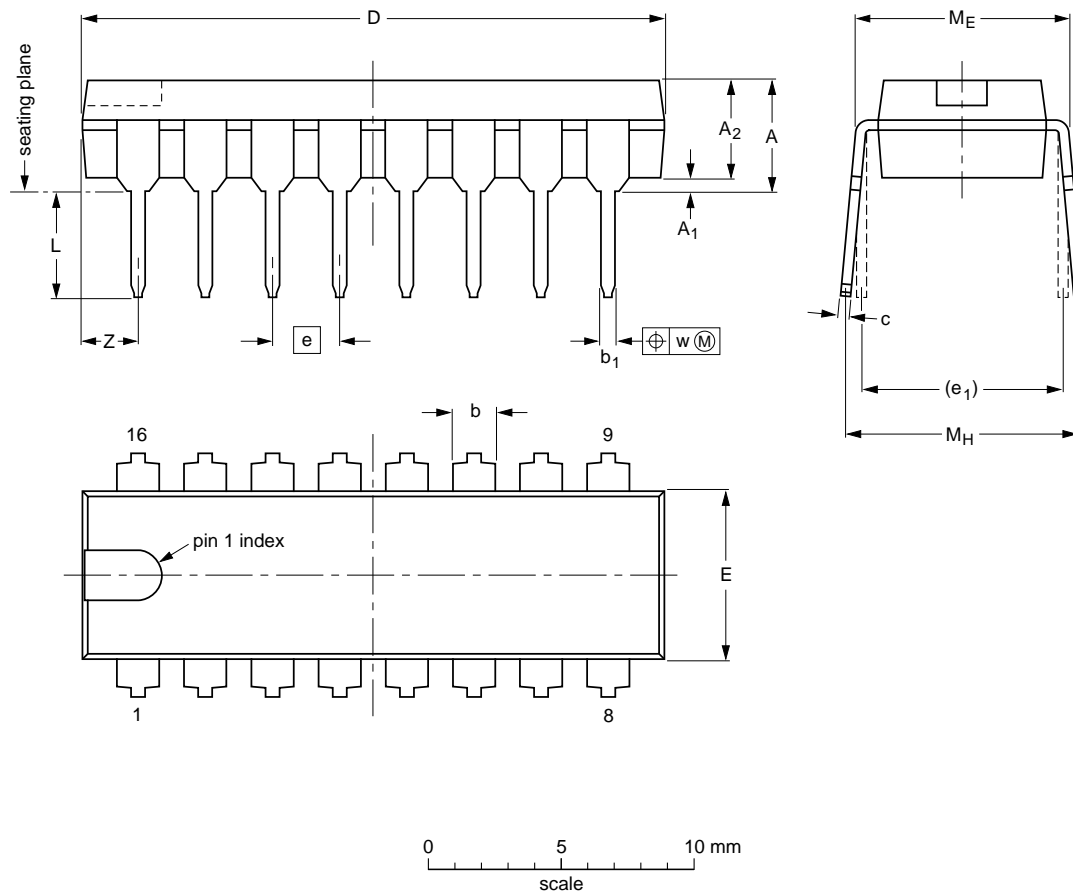

**DIMENSIONS** (inch dimensions are derived from the original mm dimensions)

UNIT	A max.	A <sub>1</sub> min.	A <sub>2</sub> max.	b	b <sub>1</sub>	c	D <sup>(1)</sup>	E <sup>(1)</sup>	e	e <sub>1</sub>	L	M <sub>E</sub>	M <sub>H</sub>	w	Z <sup>(1)</sup> max.
mm	4.7	0.51	3.7	1.40 1.14	0.53 0.38	0.32 0.23	21.8 21.4	6.48 6.20	2.54	7.62	3.9 3.4	8.25 7.80	9.5 8.3	0.254	2.2
inches	0.19	0.020	0.15	0.055 0.045	0.021 0.015	0.013 0.009	0.86 0.84	0.26 0.24	0.10	0.30	0.15 0.13	0.32 0.31	0.37 0.33	0.01	0.087

**Note**

1. Plastic or metal protrusions of 0.25 mm maximum per side are not included.

OUTLINE VERSION	REFERENCES			EUROPEAN PROJECTION	ISSUE DATE
	IEC	JEDEC	EIAJ		
SOT38-1	050G09	MO-001AE			92-10-02 95-01-19

# Stereo BTL audio output amplifier with DC volume control

## TDA7053A

SOT162: plastic small outline package; 16 leads; body width 7.5 mm

SOT162-1

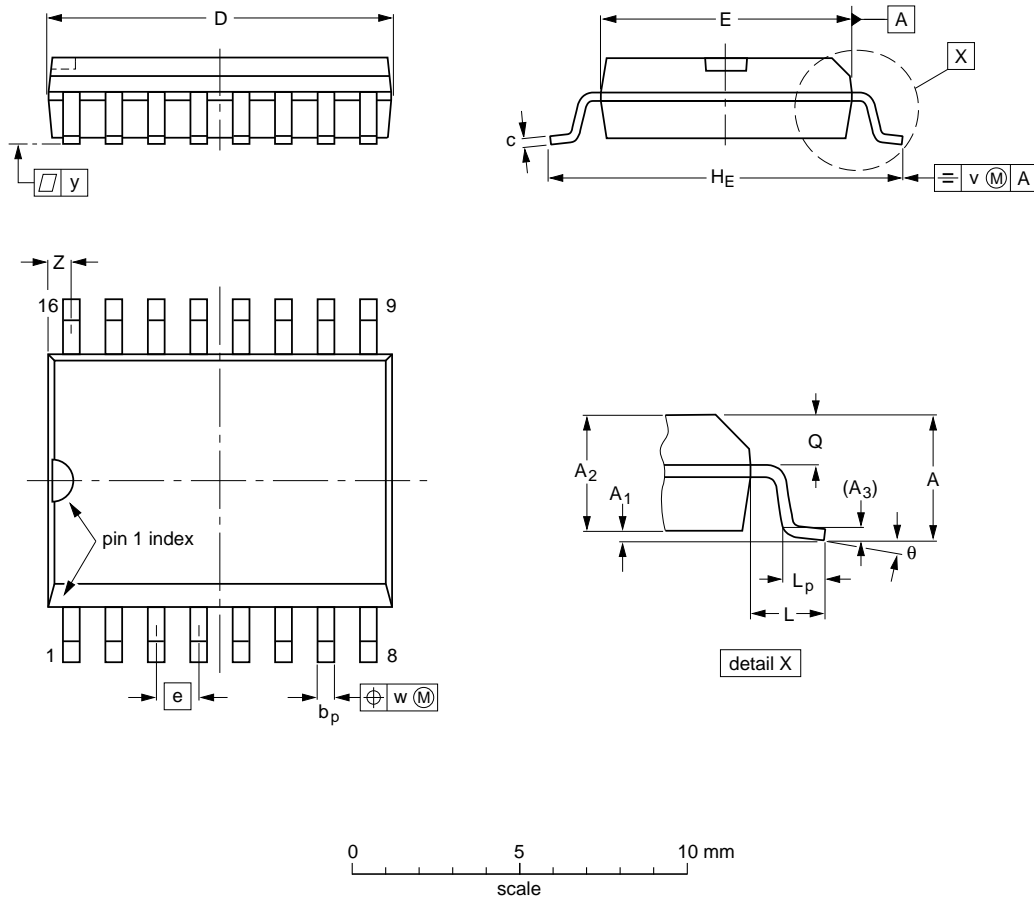

**DIMENSIONS** (inch dimensions are derived from the original mm dimensions)

UNIT	A max.	A <sub>1</sub>	A <sub>2</sub>	A <sub>3</sub>	b <sub>p</sub>	c	D <sup>(1)</sup>	E <sup>(1)</sup>	e	H <sub>E</sub>	L	L <sub>p</sub>	Q	v	w	y	z <sup>(1)</sup>	θ
mm	2.65	0.30 0.10	2.45 2.25	0.25	0.49 0.36	0.32 0.23	10.5 10.1	7.6 7.4	1.27	10.65 10.00	1.4	1.1 0.4	1.1 1.0	0.25	0.25	0.1	0.9 0.4	8° 0°
inches	0.10	0.012 0.004	0.096 0.089	0.01	0.019 0.014	0.013 0.009	0.41 0.40	0.30 0.29	0.050	0.42 0.39	0.055	0.043 0.016	0.043 0.039	0.01	0.01	0.004	0.035 0.016	

**Note**

1. Plastic or metal protrusions of 0.15 mm maximum per side are not included.

OUTLINE VERSION	REFERENCES				EUROPEAN PROJECTION	ISSUE DATE
	IEC	JEDEC	EIAJ			
SOT162-1	075E03	MS-013AA				92-11-17 95-01-24

# Stereo BTL audio output amplifier with DC volume control

TDA7053A

## SOLDERING

### Introduction

There is no soldering method that is ideal for all IC packages. Wave soldering is often preferred when through-hole and surface mounted components are mixed on one printed-circuit board. However, wave soldering is not always suitable for surface mounted ICs, or for printed-circuits with high population densities. In these situations reflow soldering is often used.

This text gives a very brief insight to a complex technology. A more in-depth account of soldering ICs can be found in our "IC Package Databook" (order code 9398 652 90011).

### DIP

#### SOLDERING BY DIPPING OR BY WAVE

The maximum permissible temperature of the solder is 260 °C; solder at this temperature must not be in contact with the joint for more than 5 seconds. The total contact time of successive solder waves must not exceed 5 seconds.

The device may be mounted up to the seating plane, but the temperature of the plastic body must not exceed the specified maximum storage temperature ( $T_{stg\ max}$ ). If the printed-circuit board has been pre-heated, forced cooling may be necessary immediately after soldering to keep the temperature within the permissible limit.

#### REPAIRING SOLDERED JOINTS

Apply a low voltage soldering iron (less than 24 V) to the lead(s) of the package, below the seating plane or not more than 2 mm above it. If the temperature of the soldering iron bit is less than 300 °C it may remain in contact for up to 10 seconds. If the bit temperature is between 300 and 400 °C, contact may be up to 5 seconds.

### SO

#### REFLOW SOLDERING

Reflow soldering techniques are suitable for all SO packages.

Reflow soldering requires solder paste (a suspension of fine solder particles, flux and binding agent) to be applied to the printed-circuit board by screen printing, stencilling or pressure-syringe dispensing before package placement.

Several techniques exist for reflowing; for example, thermal conduction by heated belt. Dwell times vary between 50 and 300 seconds depending on heating method. Typical reflow temperatures range from 215 to 250 °C.

Preheating is necessary to dry the paste and evaporate the binding agent. Preheating duration: 45 minutes at 45 °C.

#### WAVE SOLDERING

Wave soldering techniques can be used for all SO packages if the following conditions are observed:

- A double-wave (a turbulent wave with high upward pressure followed by a smooth laminar wave) soldering technique should be used.
- The longitudinal axis of the package footprint must be parallel to the solder flow.
- The package footprint must incorporate solder thieves at the downstream end.

During placement and before soldering, the package must be fixed with a droplet of adhesive. The adhesive can be applied by screen printing, pin transfer or syringe dispensing. The package can be soldered after the adhesive is cured.

Maximum permissible solder temperature is 260 °C, and maximum duration of package immersion in solder is 10 seconds, if cooled to less than 150 °C within 6 seconds. Typical dwell time is 4 seconds at 250 °C.

A mildly-activated flux will eliminate the need for removal of corrosive residues in most applications.

#### REPAIRING SOLDERED JOINTS

Fix the component by first soldering two diagonally-opposite end leads. Use only a low voltage soldering iron (less than 24 V) applied to the flat part of the lead. Contact time must be limited to 10 seconds at up to 300 °C. When using a dedicated tool, all other leads can be soldered in one operation within 2 to 5 seconds between 270 and 320 °C.

# Stereo BTL audio output amplifier with DC volume control

TDA7053A

## DEFINITIONS

<b>Data sheet status</b>	
Objective specification	This data sheet contains target or goal specifications for product development.
Preliminary specification	This data sheet contains preliminary data; supplementary data may be published later.
Product specification	This data sheet contains final product specifications.
<b>Limiting values</b>	
Limiting values given are in accordance with the Absolute Maximum Rating System (IEC 134). Stress above one or more of the limiting values may cause permanent damage to the device. These are stress ratings only and operation of the device at these or at any other conditions above those given in the Characteristics sections of the specification is not implied. Exposure to limiting values for extended periods may affect device reliability.	
<b>Application information</b>	
Where application information is given, it is advisory and does not form part of the specification.	

## LIFE SUPPORT APPLICATIONS

These products are not designed for use in life support appliances, devices, or systems where malfunction of these products can reasonably be expected to result in personal injury. Philips customers using or selling these products for use in such applications do so at their own risk and agree to fully indemnify Philips for any damages resulting from such improper use or sale.

---

Stereo BTL audio output amplifier with DC  
volume control

---

TDA7053A

**NOTES**

## Philips Semiconductors – a worldwide company

**Argentina:** IEROD, Av. Juramento 1992 - 14.b, (1428)  
BUENOS AIRES, Tel. (541)786 7633, Fax. (541)786 9367

**Australia:** 34 Waterloo Road, NORTH RYDE, NSW 2113,  
Tel. (02)805 4455, Fax. (02)805 4466

**Austria:** Triester Str. 64, A-1101 WIEN, P.O. Box 213,  
Tel. (01)60 101-1236, Fax. (01)60 101-1211

**Belgium:** Postbus 90050, 5600 PB EINDHOVEN, The Netherlands,  
Tel. (31)40-2783749, Fax. (31)40-2788399

**Brazil:** Rua do Rocio 220 - 5<sup>th</sup> floor, Suite 51,  
CEP: 04552-903-SÃO PAULO-SP, Brazil.  
P.O. Box 7383 (01064-970),  
Tel. (011)821-2333, Fax. (011)829-1849

**Canada:** PHILIPS SEMICONDUCTORS/COMPONENTS:  
Tel. (800) 234-7381, Fax. (708) 296-8556

**Chile:** Av. Santa Maria 0760, SANTIAGO,  
Tel. (02)773 816, Fax. (02)777 6730

**China/Hong Kong:** 501 Hong Kong Industrial Technology Centre,  
72 Tat Chee Avenue, Kowloon Tong, HONG KONG,  
Tel. (852)2319 7888, Fax. (852)2319 7700

**Colombia:** IPRELENZO LTDA, Carrera 21 No. 56-17,  
77621 BOGOTA, Tel. (571)249 7624/(571)217 4609,  
Fax. (571)217 4549

**Denmark:** Prags Boulevard 80, PB 1919, DK-2300  
COPENHAGEN S, Tel. (032)88 2636, Fax. (031)57 1949

**Finland:** Sinikalliontie 3, FIN-02630 ESPOO,  
Tel. (358)0-615 800, Fax. (358)0-61580 920

**France:** 4 Rue du Port-aux-Vins, BP317,  
92156 SURESNES Cedex,  
Tel. (01)4099 6161, Fax. (01)4099 6427

**Germany:** P.O. Box 10 63 23, 20043 HAMBURG,  
Tel. (040)3296-0, Fax. (040)3296 213.

**Greece:** No. 15, 25th March Street, GR 17778 TAVROS,  
Tel. (01)4894 339/4894 911, Fax. (01)4814 240

**India:** Philips INDIA Ltd, Shivsagar Estate, A Block,  
Dr. Annie Besant Rd. Worli, Bombay 400 018  
Tel. (022)4938 541, Fax. (022)4938 722

**Indonesia:** Philips House, Jalan H.R. Rasuna Said Kav. 3-4,  
P.O. Box 4252, JAKARTA 12950,  
Tel. (021)5201 122, Fax. (021)5205 189

**Ireland:** Newstead, Clonskeagh, DUBLIN 14,  
Tel. (01)7640 000, Fax. (01)7640 200

**Italy:** PHILIPS SEMICONDUCTORS S.r.l.,  
Piazza IV Novembre 3, 20124 MILANO,  
Tel. (0039)2 6752 2531, Fax. (0039)2 6752 2557

**Japan:** Philips Bldg 13-37, Kohnan2-chome, Minato-ku, TOKYO 108,  
Tel. (03)3740 5130, Fax. (03)3740 5077

**Korea:** Philips House, 260-199 Itaewon-dong,  
Yongsan-ku, SEOUL, Tel. (02)709-1412, Fax. (02)709-1415

**Malaysia:** No. 76 Jalan Universiti, 46200 PETALING JAYA,  
SELANGOR, Tel. (03)750 5214, Fax. (03)757 4880

**Mexico:** 5900 Gateway East, Suite 200, EL PASO, TX 79905,  
Tel. 9-5(800)234-7381, Fax. (708)296-8556

**Netherlands:** Postbus 90050, 5600 PB EINDHOVEN, Bldg. VB,  
Tel. (040)2783749, Fax. (040)2788399

**New Zealand:** 2 Wagener Place, C.P.O. Box 1041, AUCKLAND,  
Tel. (09)849-4160, Fax. (09)849-7811

**Norway:** Box 1, Manglerud 0612, OSLO,  
Tel. (022)74 8000, Fax. (022)74 8341

**Pakistan:** Philips Electrical Industries of Pakistan Ltd.,  
Exchange Bldg. ST-2/A, Block 9, KDA Scheme 5, Clifton,  
KARACHI 75600, Tel. (021)587 4641-49,  
Fax. (021)577035/5874546

**Philippines:** PHILIPS SEMICONDUCTORS PHILIPPINES Inc.,  
106 Valero St. Salcedo Village, P.O. Box 2108 MCC, MAKATI,  
Metro MANILA, Tel. (63) 2 816 6380, Fax. (63) 2 817 3474

**Portugal:** PHILIPS PORTUGUESA, S.A.,  
Rua dr. António Loureiro Borges 5, Arquiparque - Miraflores,  
Apartado 300, 2795 LINDA-A-VELHA,  
Tel. (01)4163160/4163333, Fax. (01)4163174/4163366

**Singapore:** Lorong 1, Toa Payoh, SINGAPORE 1231,  
Tel. (65)350 2000, Fax. (65)251 6500

**South Africa:** S.A. PHILIPS Pty Ltd.,  
195-215 Main Road Martindale, 2092 JOHANNESBURG,  
P.O. Box 7430, Johannesburg 2000,  
Tel. (011)470-5911, Fax. (011)470-5494

**Spain:** Balmes 22, 08007 BARCELONA,  
Tel. (03)301 6312, Fax. (03)301 42 43

**Sweden:** Kottbygatan 7, Akalla. S-164 85 STOCKHOLM,  
Tel. (08)-632 2000, Fax. (08)-632 2745

**Switzerland:** Allmendstrasse 140, CH-8027 ZÜRICH,  
Tel. (01)488 2211, Fax. (01)481 77 30

**Taiwan:** PHILIPS TAIWAN Ltd., 23-30F, 66, Chung Hsiao West  
Road, Sec. 1. Taipei, Taiwan ROC, P.O. Box 22978,  
TAIPEI 100, Tel. (886) 2 382 4443, Fax. (886) 2 382 4444

**Thailand:** PHILIPS ELECTRONICS (THAILAND) Ltd.,  
209/2 Sanpavuth-Bangna Road Prakanong,  
Bangkok 10260, THAILAND,  
Tel. (66) 2 745-4090, Fax. (66) 2 398-0793

**Turkey:** Talatpasa Cad. No. 5, 80640 GÜLTEPE/ISTANBUL,  
Tel. (0212)279 27 70, Fax. (0212)282 67 07

**Ukraine:** Philips UKRAINE, 2A Akademika Koroleva str., Office 165,  
252148 KIEV, Tel. 380-44-4760297, Fax. 380-44-4766991

**United Kingdom:** Philips Semiconductors LTD.,  
276 Bath Road, Hayes, MIDDLESEX UB3 5BX,  
Tel. (0181)730-5000, Fax. (0181)754-8421

**United States:** 811 East Arques Avenue, SUNNYVALE,  
CA 94088-3409, Tel. (800)234-7381, Fax. (708)296-8556

**Uruguay:** Coronel Mora 433, MONTEVIDEO,  
Tel. (02)70-4044, Fax. (02)92 0601

**Internet:** <http://www.semiconductors.philips.com/ps/>

**For all other countries apply to:** Philips Semiconductors,  
International Marketing and Sales, Building BE-p,  
P.O. Box 218, 5600 MD EINDHOVEN, The Netherlands,  
Telex 35000 phtcnl, Fax. +31-40-2724825

SCD45 © Philips Electronics N.V. 1995

All rights are reserved. Reproduction in whole or in part is prohibited without the prior written consent of the copyright owner.

The information presented in this document does not form part of any quotation or contract, is believed to be accurate and reliable and may be changed without notice. No liability will be accepted by the publisher for any consequence of its use. Publication thereof does not convey nor imply any license under patent- or other industrial or intellectual property rights.

Printed in The Netherlands

513061/1100/03/pp16  
Document order number:

Date of release: 1995 Nov 09  
9397 750 00426

*Let's make things better.*